

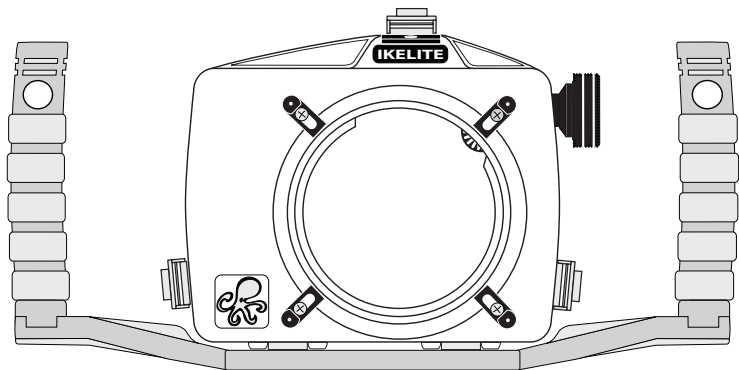

SLR-DC Housing

instruction manual

6871.50 Canon 450D,500D, Rebel XSi,T1i, Kiss X2, X3



Thank you for your purchase of Ikelite equipment. Please read this instruction manual completely before attempting to operate or dive with this product. Please refer to the back page of this manual to register your Ikelite product.

Table of Contents

Specifications	P. 3
Package Contents	P. 4
Preparation	P. 4
Attach External “Tray with Handles” to Housing	P. 4
Parts of the Housing - Front/Side View	P. 5
Parts of the Housing - Back View	P. 6
Initial Camera Setup.....	P. 7
Opening the Housing	P. 7
Housing Conversion Circuitry.....	P. 8
Setting the Conversion Circuitry Strobe ID Switch.....	P. 8
Using the Conversion Circuitry.....	P. 9
Using Non-Ikelite or Ikelite Non-DS Substrobes	P. 9
DS50 and DS125 Substrobe Compatibility	P. 10
Attaching the Flash Connection for External Strobes	P. 10
Attach Camera to Housing Tray	P. 11
Installing Camera in Housing	P. 11
Closing the Housing	P. 12
Final Check	P. 12
Attaching a Sync Cord to the Housing	P. 13
Turn Camera On.....	P. 13
Zoom Clamp & Gear Sleeve Installation	P. 14
Manual Focusing	P. 18
Installing the Port	P. 19
Lens Ports	P. 20
Attaching an Ikelite Strobe Arm to the Housing Handle..	P. 21

Table of Contents - continued

Usage	P. 22
Pre-Dive Your System	P. 22
Lubricants	P. 22
Troubleshooting	P. 23
Recommended Accessories	P. 25
Accessory Mounting Points	P. 25
EV-Controller Use.....	P. 25
Maintenance	P. 26
Storing the Housing	P. 29
Spare Parts	P. 29
Photo Tips	P. 29
Technical Support	P. 30
Limited Warranty	P. 31
Returning Products for Service	P. 31
Product Registration	Back Cover

Specifications

Controls	All important camera functions are accessible
Width	10in (250mm) including controls
Height	6.7in (170mm) including controls
Depth	6.5in (165mm) including controls
Weight	5.3lb (2400g) without tray & handles
Buoyancy	Neutral in freshwater dependant on lens & port choice
Built-in Flash	No
Strobe Connection	Ikelite digital TTL electrical bulkhead
Tray Mounting	12-24 thread with 3in spacing (76mm)

Package Contents

- SLR-DC Housing
- Envelope containing tray installation hardware, maintenance kit, and extra control end tips.
- Aluminum Tray & Dual Handles
- Silicone Lubricant
- Standard Zoom Clamp & Sleeve Set
- #5509.28 Large Diameter Zoom Clamp & Sleeve Set

Preparation

This product has been water pressure tested at the factory and is depth rated to 200 ft. (60m). Thoroughly inspect and immerse the empty housing completely in water before installing a camera. If any fogging occurs or droplets of water enter the housing, do not install a camera. Clean the housing main o-ring and retest to make sure that it is watertight. Refer to the Troubleshooting section, page 23.

We suggest that you read this instruction booklet thoroughly before use to have a full understanding of where each camera control is located, and what function each control provides. Please read your camera manual thoroughly to have a full understanding of each camera function. If you are new to underwater photography, be sure to read the Photo Tips section.

Due to the power required to operate the camera and LCD screen start each dive with a fully charged camera battery.

Attach External “Tray with Handles” to Housing

Use hardware and instructions located in the clear Ikelite pouch to attach the “Tray with Handles” to your Ikelite housing.

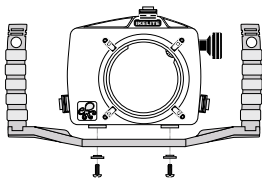

Parts of the Housing - Front View

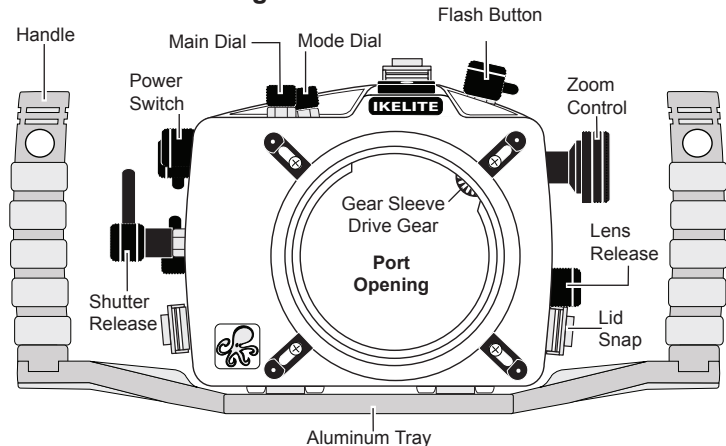

Side View

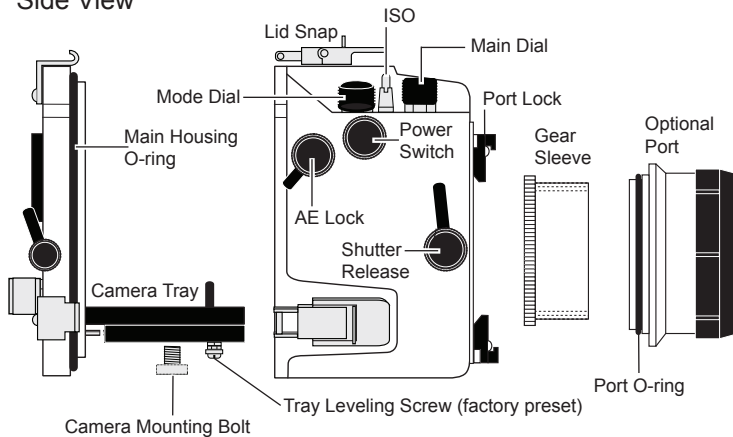

Back View

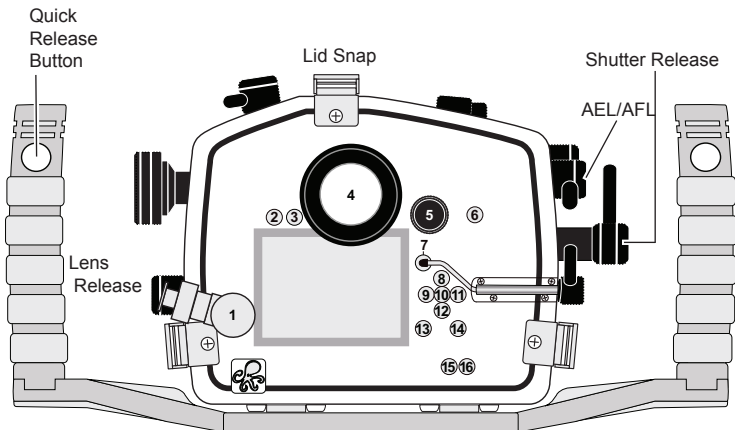

1. Strobe Connector and Waterproof Cap

2. Menu Button

3. Display Button

4. Optical Viewfinder

5. "Av" Aperture, 

6. AF Point Button

7. White Balance Button, Video ON (T1i only)

8. Cross Key, White Balance, 

9. Cross Key, Drive Mode, 

10. Setting Button 

11. Cross Key, AF Mode, 

12. Cross Key, Picture Style, 

13. Playback Button 

14. Erase Button 

15 & 16. Flash Mode and Compensation Buttons

Initial Camera Setup

- Insert a fully charged battery.
- Insert memory card (2GB or greater capacity recommended).
- Set the mode dial to “M” manual.
- Set shutter speed to 1/60th second or 1/125th second for fast moving subjects.
- Set aperture to F8 for general photography or F22 for macro photography (close-ups).
- Set Quality to highest jpeg setting or RAW.
- Set ISO to 100 and Meter to “center-weighted.”
- Disable “LCD auto-off” in the camera menu settings.
- If using auto-focus in “Live-View”, use “Quick-Mode.”
NOTE: Auto-focus will not be as good in “Live-View” mode.
- Disable “Auto Lighting Optimizer.”
- Set auto-focus mode to “One Shot.”
- Set “Hightlight Tone Priority” to “OFF.”
- Disable “Red-eye reduction.”
- Disable “Mirror Lock-Up.”

Opening the Housing

Lid Snaps have a **Lock**. To open, push Lid Snap Lock forward and lift as shown. Keep pressure on the Lid Snap so it does not fly open quickly.

Some Lid Snaps have a lot of spring tension once they go over center, so have a firm grip on the Lid Snap. Lid Snaps may be opened one at a time.

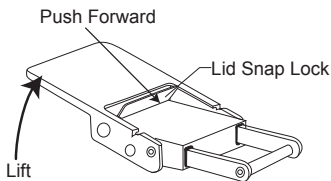

Housing Conversion Circuitry

This housing contains Ikelite designed and patented Conversion Circuitry. Once attached, turn the strobe on first before turning on the camera.

When used with Ikelite DS Substrobes the Conversion Circuitry provides real Nikon iTTL flash exposure with over and underexposure compensation from +1 1/3 to - 1 1/3 f-stops in 1/3 stop increments.

The Conversion Circuitry also offers Manual exposure control with 3 1/2 f-stops of underexposure control in 1/2 stop increments.

The Conversion Circuitry is powered by the Ikelite DS Substrobe when connected to the housing with the 4103.51 single or 4103.52 dual sync cord. When using two strobes with the dual sync cord, the primary strobe connected to the cord without the red band, must be turned on to power the Conversion Circuitry. Always keep both strobes connected to your dual sync cord underwater. Do not exchange your secondary strobe for a dust cap which may not be waterproof.

Setting the Conversion Circuitry Strobe ID Switch

On the housing back is a switch for setting the DS Substrobe ID. Set the switch to the Model of DS Substrobe being used.

When using dual strobes of different models such as a DS51 and a DS161, set the ID switch to DS51 or the smaller strobe.

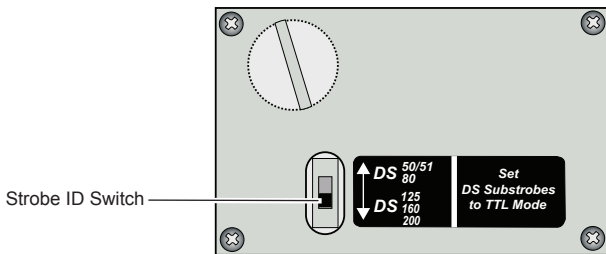

Using the Conversion Circuitry (Set DS Substrobe to TTL mode)

- Mode and Compensation Buttons

The Conversion Circuitry default is set to TTL. To switch between TTL and Manual Modes, depress both Mode Buttons at the same time and keep them depressed until you see the desired Yellow LED Mode illuminate.

- **TTL Mode** (indicated when the yellow LED directly below TTL is illuminated). TTL Mode is the default setting. When the DS Substrobe is powered ON, the yellow TTL LED will illuminate. None of the Red LEDs will illuminate. This indicates that no (+) plus or (-) minus compensation is selected. Depress the Mode buttons to select +/- compensation. Note that the TTL +/- compensation values are in the yellow bar with the heading TTL.
- **Manual Mode** (indicated when the yellow LED directly below the M is illuminated). When the Manual Mode is selected, the Red LED directly below the F (full power) will illuminate. Note that the Manual minus (-) compensation values are in the black bar with the heading M. **Set DS Substrobe to TTL mode. This will allow the strobe power to be varied in manual mode.**

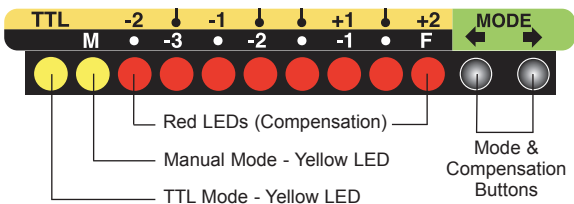

Using Non-Ikelite or Ikelite Non-DS Substrobes (Substrobe 50, 100A, 200, 400) with this Housing

The Conversion Circuitry is automatically disabled when used with a Non-Ikelite or Non-DS Substrobe. These Substrobes can be used in their manual mode utilizing any power settings provided on the Substrobe.

DS50 and DS125 Substrobe Compatibility

- Older **DS50** Substrobes with Serial Number below 63,850 can NOT be updated to operate correctly with the latest TTL conversion circuitry. Older **DS50** Substrobes with Serial Number between 63,850 and 69,999 require upgrade of electronics to operate. Cost of update depends on strobe circuitry. Strobe must be returned to Ikelite for evaluation to provide an estimate of upgrade cost.
- Older **DS125** Substrobes with Serial Number below 2,500 can NOT be updated to operate correctly with the latest TTL conversion circuitry. Older **DS125** Substrobes with Serial Number between 2,500 and 4,999 require upgrade of electronics to operate. Cost of update depends on strobe circuitry. Strobe must be returned to Ikelite for evaluation to provide an estimate of upgrade cost.

Attaching the Flash Connection for External Strobes

When using an external strobe, connect the housing hotshoe connector. Slide the connector into the hotshoe mount on the camera from the back of the camera as shown. Slide the connector forward until it stops. Due to limited clearance between the camera hotshoe mount and the housing back, the hotshoe connector should be attached before the camera is secured with the mounting bolt.

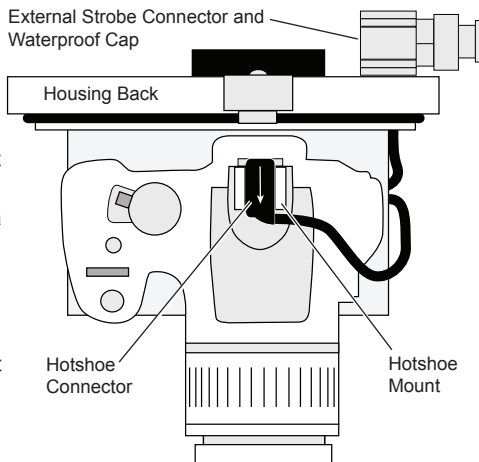

Attaching Camera to Housing Tray

Remove the back from the housing. The mounting tray for the camera is secured to the housing back. Position the camera and lens on the camera tray, and then secure it with the mounting bolt which threads into the camera's tripod socket.

Use a flathead screwdriver (recommended) or coin to tighten the Mounting Bolt so the camera bottom is flush against the tray.

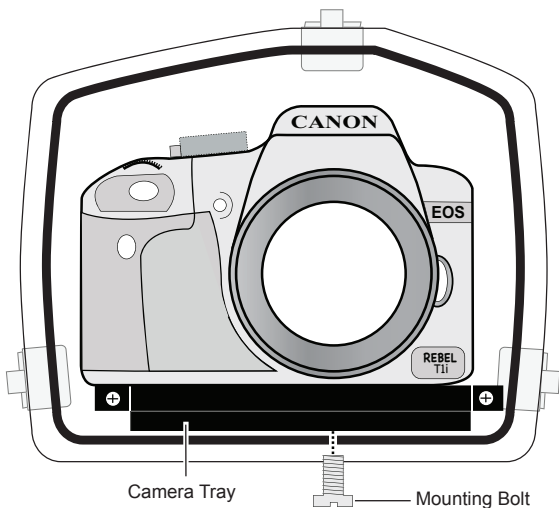

Installing Camera in Housing

Before installing the camera, pull out on the controls in the front section of the housing. This will allow the camera to slide in easier. Once the camera is installed and the lid snaps have been closed, return the controls to their operating position.

Closing the Housing

1. Place housing face down in your lap.
2. Check to see that there is an o-ring on the housing back that is clean and in its proper location.
3. Guide the back onto the housing. The o-ring should touch the housing all the way around. There should be an even gap all the way around between the housing and the housing back.
4. Lift the lid snaps so they are extended and place the lid snap into the corresponding hook on the housing back.
5. To close the housing, push down on the lid snaps until they snap into place. Lid snaps on opposite sides of the housing should be closed at the same time. Be sure they are down far enough to engage the lid snap lock.

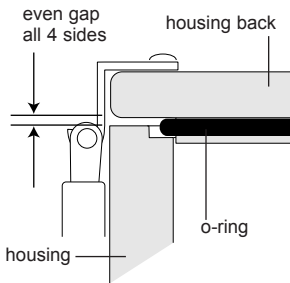
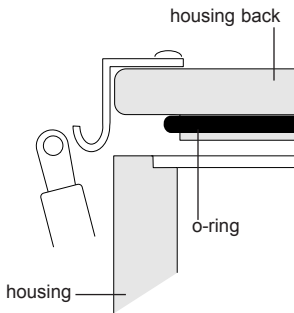

Final Check

Once the housing is closed, check the o-ring seal. Check the gap between the housing back and the housing. It should be even all the way around the housing.

Look through the clear plastic back at the o-ring. You should see a darkened area where the o-ring is compressed against the housing back. If you do not see an even black compression seal all the way around the back, open the lid snaps, reseal the housing back and close the lid snaps. Visually check the seal again.

Attaching a Sync Cord to the Housing

The Housing Bulkhead is designed to accept only an Ikelite 5-pin TTL Sync Cord.

1. Lightly lubricate the Sync Cord O-ring. Use **ONLY** Ikelite lubricant (supplied with housing).
2. Remove Bulkhead Cap from Housing Bulkhead.
3. Line up the Sync Cord Pins with the corresponding Bulkhead receptacles. Gently insert Sync Cord into Bulkhead. **DO NOT** force this installation. *If the Sync Cord does not seat properly inside the Bulkhead, the pins and receptacles are improperly aligned (repeat Step 3).*
4. Tighten the Knurled Nut snugly using your Index finger and thumb. **DO NOT** use pliers or other tools to tighten the Knurled Nut.

Always remove the Sync Cord from your Housing when not in use, and replace the Bulkhead Cap.

Caution:

Do not remove the waterproof Bulkhead Cap unless an external sync cord is going to be plugged in. Do not remove Bulkhead Cap or Sync Cord underwater.

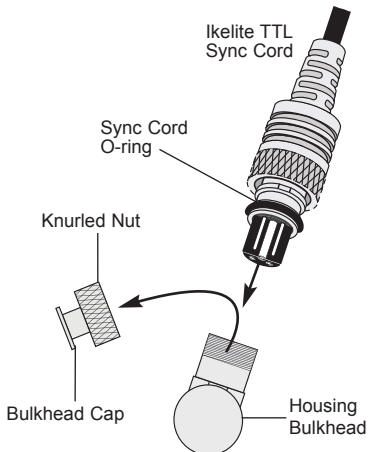

Turn Camera On

Turn the camera on and operate each of the housing controls to get a feel for using the camera in the housing. Take a few test shots on land.

You are now ready to shoot underwater photos and video!

Preparing to Install Zoom Clamp & Gear Sleeve

Determine the type of lens being used on the camera.

Type 1 Lenses have a lens opening that is NOT larger in diameter than the zoom ring. (**Fig. 1**).

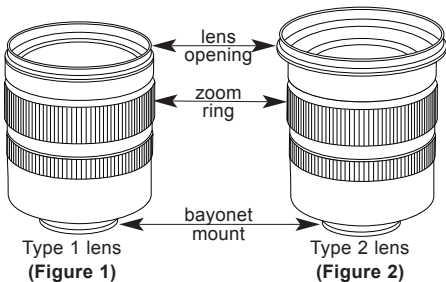

Type 2 Lenses have a lens opening that IS larger in diameter than the zoom ring. (**Fig. 2**).

Zoom Clamps & Gear Sleeves Included with Housing

There are 2 different Zoom Clamps and Gear Sleeves provided with the housing. Start with the suggested Zoom Clamp and Gear Sleeve depending on the Type of lens being used. See (**Fig. A or B**)

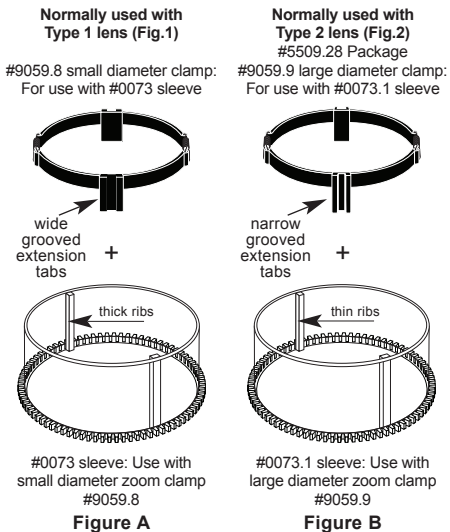

Installing the Zoom Clamp & Gear Sleeve On the Type 1 Lenses

The Zoom Clamp has springs so it can be expanded to fit over the Zoom Ring of the lens - figure C, page 15.

Install the Zoom Clamp with the extension tabs toward the rear element of the lens. After installing the Zoom Clamp and Gear Sleeve - figures D & E, page 16, install the Lens Port and rotate the Zoom Ring on the lens. If the Zoom Ring and Gear Sleeve do not mesh properly, install the rubber strips (supplied) to the inside diameter of the Zoom Clamp as shown in figure F, page 16.

Two thicknesses of rubber strips are provided. Start by installing the thinnest rubber strips. If the Zoom Clamp still is not tight enough and meshes improperly with the Gear Sleeve, use the thicker rubber strips. Reinstall the Zoom Clamp, Sleeve. Mesh Gear Sleeve teeth with Black Housing Drive Gear, figure G, page 18, and then install the Lens Port. After installing the port, pages 19 & 20, rotate the housing Zoom Control Knob to see that the Gear Sleeve is properly rotating the lens Zoom ring.

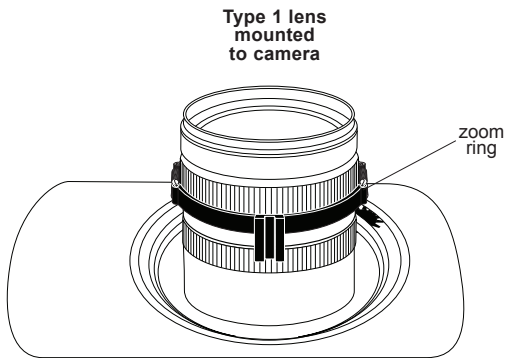

Figure C

Type 1 Lenses - continued

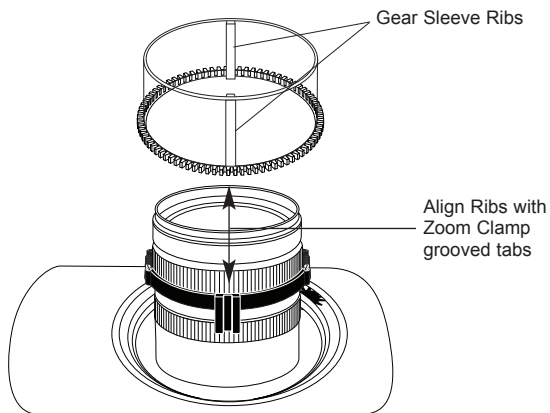

Figure D

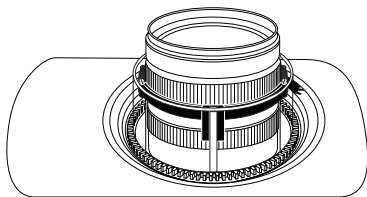

Figure E

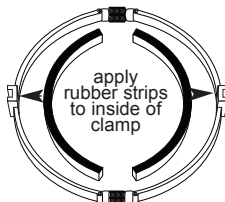

Figure F

Installing the Zoom Clamp & Gear Sleeve On Type 2 Lenses

Due to the larger diameter lens opening on Type 2 lenses, the Zoom Clamp and Gear Sleeve need to be installed from the rear (bayonet end) of the lens. Use the housing Lens Release Control and remove the camera lens from the camera body, after the camera and lens have been installed in the housing.

Place the Gear Sleeve in the housing opening as shown.

Install the black Zoom Clamp on the Lens Zoom Ring and lower the lens into the housing opening. Make sure the Zoom Clamp grooved tabs align with the Gear Sleeve ribs. If necessary, install rubber strips to expand the Zoom Clamp so it meshes properly with the Gear Sleeve. Bayonet lens into camera body and align Gear Sleeve teeth with Black Housing Gear Teeth.

Type 2 lens

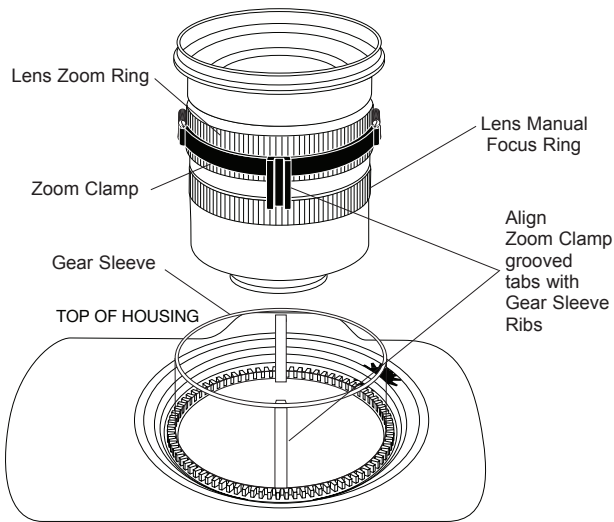

Installing Zoom Clamp/Sleeve on Type 2 Lenses - continued

Before installing the lens port and checking operation, make sure the teeth on the Gear Sleeve mesh with the teeth on the housing Drive Gear, shown below. When the port is installed, pages 19 & 20, it will lock the Gear Sleeve in place. After installing the port, rotate the housing Zoom Control Knob to see that the Gear Sleeve is properly rotating the Lens Zoom ring.

Manual Focusing

Ikelite DSLR housings are designed for auto-focus DSLR cameras and lenses. Manual focusing is not recommended. In some cases, if you desire to manually focus a lens, the zoom clamp must be moved onto the lens Manual Focus Ring and you must use the housing zoom control knob to manually focus. This will result in loss of zoom capability.

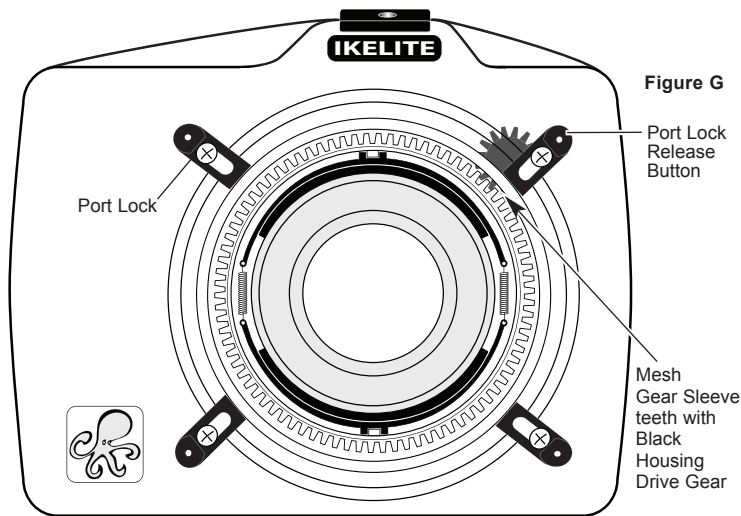

Installing the Port

There are four port locks on the front of the housing, see figure G, page 18. Each port lock has a Release Button. Lift the release button and slide each Port Lock away from the port opening. In the unlocked position, the Release Button will remain in the up position as shown.

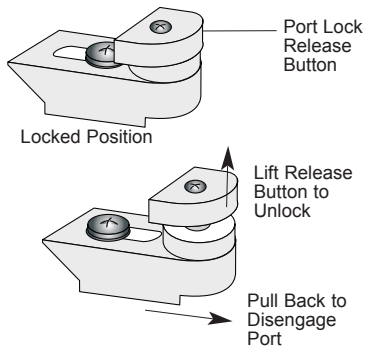

To prepare the port for installation, remove the port o-ring and lightly lubricate it. The port seal is a side-to-side seal and requires the o-ring to be lightly lubricated for easy installation. Put a small amount of lubricant on your fingers and pull the o-ring through your fingers to lightly lubricate it. Do not stretch the o-ring. Check that the lip of the port where the o-ring fits and the sealing surface on the housing are clean. Place the port, with o-ring, into the housing port opening. Press down on the port firmly and evenly until you feel the port slide into place. Continue to push down on the port and push each port lock forward until the lock fully engages. It may help to slightly rotate the port as you push in on the port lock. Visually inspect each port lock and confirm that the Port Lock Release Button is seated flush against the Port Lock Body. Do not rely on an audible "click" to indicate that the lock is engaged.

Check around the perimeter of the port seal to see that the o-ring is properly sealed and not extruded, figure 2, page 20.

It is NOT necessary to tighten housing port locks after installing a port. Port locks are factory adjusted. Slight port movement is normal after port locks have been closed and port has been secured to the housing.

Installing the Port - continued

To Remove Port

To remove the port, lift up on each Release Button and slide the port lock away from the port.

Port Seal Inside View

If the port is installed before the camera is inserted into the housing, look from the inside of the housing at the port seal.

Check to see that the o-ring is properly seated as shown in figure 1 and not extruded as shown in figure 2.

Fig. 1

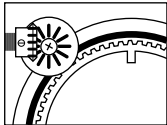
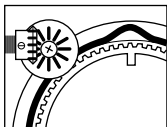

Fig. 2



Caution:

After installing the port, turn the Zoom Control knob on the housing. If the Zoom Control is difficult to turn, the gear sleeve may be warped. If necessary, reduce or omit any rubber installed on the Zoom Clamp, figure F, page 16. *If the Zoom Clamp is still warped, use of the 5509.28 package may be required, see page 14.*

Lens Ports

A lens port must be secured to the housing before entering the water. Ikelite DSLR housings DO NOT come with a lens port. You must select the correct port for each lens you will be using underwater. For complete lens port information and compatibility with your Ikelite system, go to www.ikelite.com.

Attaching an Ikelite Strobe Arm to the Housing Handle

To attach an Ikelite Arm to your Housing Handle, depress the spring-loaded Handle Push Button until it stops. Gently slide the pronged end of the Ikelite Arm into the hole in the top of the Handle as shown.

When the Ikelite Arm is properly seated, the Handle Push Button will return to its starting position.

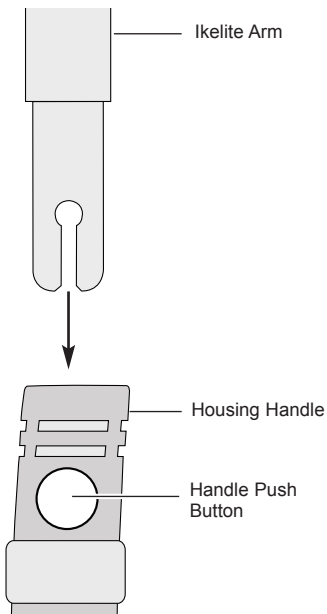

Usage

Pre-Dive Your System

It is recommended that you take the complete system into a swimming pool before use in open water. This will give you a chance to become familiar with the handling and operation of your housing and strobe(s).

As soon as you enter the water, take a moment and check the housing to see that it is properly sealed. Next, check to see if there are any bubbles on the face of the port. If there are, take your fingers and remove them. If there are bubbles on the lens port they can produce soft focus spots in your photographs.

Lubricants

Ikelite provides silicone lubricant with the housing. We recommend that you use only Ikelite lubricant. Other brands may cause the o-ring to swell and not seal properly.

Use only enough Ikelite lubricant to lightly cover control shafts and o-rings. Wipe off any excess lubricant with a clean cloth. Lubricant is not a sealant and is used to reduce friction. Excessive lubricant can collect sand and dirt which may interfere with proper sealing.

Note: Lubricant is not needed on the main housing o-ring to maintain a housing seal, however, lightly lubricating this o-ring can extend it's life and aid in seeing a good housing seal. Too much lube can attract debris increasing the potential for a leak.

CAUTION: Never use spray lubricants as the propellant ingredient can cause the plastic housing to crack. Use ONLY Ikelite lubricant.

Troubleshooting

Problem	Solution
Push buttons or controls are sticky and hard to operate	<ul style="list-style-type: none">- Remove the camera and rinse the closed housing in fresh water. Vigorously press each push button in and out several times to release any trapped saltwater or debris.- Press a sticky push button all the way in and place a small amount of lube on the small end of the push button shaft at it's base. Release and operate the push button several times to distribute the lube.- If a control is sticky, grab the control knob, pull it out, and then push back in. If still sticky, see the Control Maintenance section - pages 26 & 27.- Return housing to Ikelite for routine maintenance.
Image is over- or under-exposed	<ul style="list-style-type: none">- Check that the strobe(s) are firing when taking a picture.- When using an external strobe, make sure it is turned on, set properly, and it's battery is charged.- Check any corded connection points.- Adjust camera shutter speed, aperture, or exposure compensation.- Move closer to or further away from the subject.
Water enters the housing	<ul style="list-style-type: none">- Remove, clean and properly lubricate the main housing and port o-rings.- Look for hairs, dirt, or foreign debris crossing the o-ring seal.- Reassemble the housing without a camera installed and pressure test or take diving.- Return housing to Ikelite for routine maintenance.

Problem	Solution
Camera does not take a picture	<ul style="list-style-type: none"> - Install a fully charged battery. - A housing control is engaging a camera function and will not allow the shutter to fire. - There is not enough available light for the camera to properly focus. Add a focusing light or strobe with a built-in focusing light to your system. - Select a center focus point in your camera menu.
Housing is hard to close	<ul style="list-style-type: none"> - Make sure the camera is mounted properly on the camera tray and housing controls are out of the way .
Fogging occurs on the Lens Port	<ul style="list-style-type: none"> - Humid air is trapped inside the housing. The camera produces heat and may condense any trapped moisture forming fog on the lens port. Close the housing in an air-conditioned room or vehicle, or in front of an air-conditioner. - The housing should not be in direct sunlight for an extended period of time. - Purchase desiccant packs from a local camera store and place one or two packs in your housing before each day of diving. - If water droplets or moisture is present around the controls or sealing areas, return the housing to Ikelite for evaluation. - Clean the main housing o-ring, port o-ring, and sealing surfaces of the housing.
Pictures are too blue or too green	<ul style="list-style-type: none"> - Use custom (manual) white balance if available. - Add an external strobe. - Move in closer to your subject when taking a picture.

Recommended Accessories

A full range of accessories are available to support your housing. Please visit www.ikelite.com to see the most current information about recommended accessories for your housing.

Accessory Mounting Points

The top of the SLR-DC housing features a 1/4-20 threaded mounting point for the attachment of a focus light, video light or other lightweight accessories. DO NOT attach heavy items to this mount and always use the correct length screw to attach a component.

The bottom of the SLR-DC housing tray also features five 1/4-20 threaded mounting points for attachment of a tripod or other accessories.

EV-Controller Use

TTL flash control is not available when using an EV-Controller, and therefore an EV-Controller is not recommended for use with this housing.

Note: The EV-Controller cannot be used as a slave. If hardwired to the housing, set the EV-Controller to Non pre-flash.

The EV-Controller used with Ikelite DS Substrobes has two user settings. One setting is for strobe selection, the other is for pre-flash “P” or non pre-flash “⊘.” Most cameras use a pre-flash. This means the EV-Controller should be set to the pre-flash “P” position when used with this camera as a slave. If a manual mode is used that does not emit a pre-flash, set the EV-controller to the non pre-flash “⊘” position.

Maintenance

Control Maintenance

Ikelite controls are designed to provide years of reliable service with minimal maintenance.

- Push button controls require no maintenance other than rinsing in fresh water after saltwater use. If a push button control becomes difficult to push or if it sticks when depressed, soak the housing in luke warm fresh water. After a few minutes, operate the push button. If this does not correct the problem, return the housing to Ikelite for maintenance.
- Some of the controls have long shafts. These controls can be pulled out, exposing the shaft, diagram B, page 27.

To lubricate the control, gently pull on the knob until the stainless steel shaft is exposed. Lightly lubricate the shaft, then move the shaft in and out several times. This will lubricate the x-ring in the Ikelite control gland. This should be done before using the housing after a prolonged storage period, or once a week when the housing is in constant use.

- Some of the controls have a short shaft and cannot be pulled out exposing the shaft for lubrication. In the unlikely event one of these controls sticks or becomes difficult to operate you can remove the control from the housing and lubricate it, or return the housing to Ikelite for maintenance. To remove the control, diagram A, page 27, loosen the set screw in the knob (allen wrench required); remove the knob. If there is salt or dirt build-up on the exposed control shaft, clean the shaft. Open the housing and gently slide the control shaft out of the control gland. Clean and lightly lubricate the shaft, including the end of the shaft. Slide the shaft back into the control gland and gently slide it back and forth a few times without fully removing the shaft from the gland. Replace the knob noting the flat area on the shaft. The set screw in the knob should tighten down against the flat area on the control, so the knob does not turn on the shaft.

Diagram A

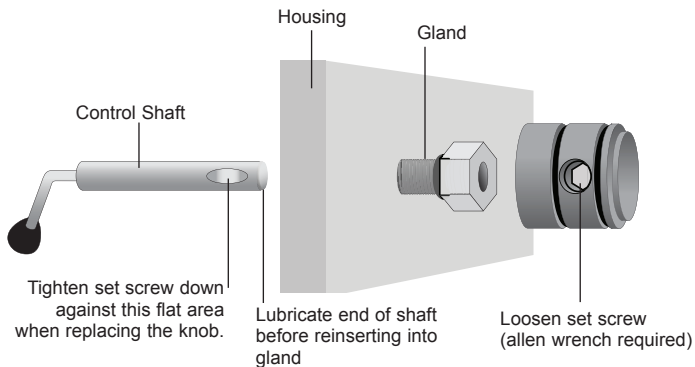
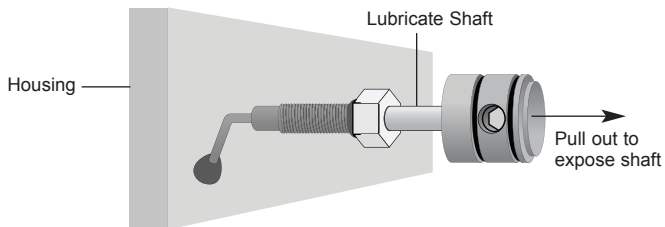

Diagram B



Housing Maintenance

Your Ikelite Housing should be given the same care and attention as your other photographic equipment. In addition to normal maintenance, we recommend your housing be returned to Ikelite (every 2-3 years or 50 dives), to be checked and pressure tested.

- **Do Not** leave the camera and housing in direct sunlight for prolonged periods. Heat may damage the camera.
- **Do Not** ship the camera in the housing.
- Before using the housing, always check the tightness of the **set screw** in each control knob.

Check each **control gland** penetrating the housing to make sure they are tight. There is a slight chance that either could vibrate loose during travel.

- Keep the back and port o-ring clean and lightly lubricated. To lubricate, remove the o-ring from the back. Put a small amount of Ikelite lubricant on your fingers. Pull the o-ring through your fingers to apply a light coating of lubricant. Only apply enough lubricant to make the o-ring feel slick. **Do Not stretch the o-ring**. This light coating of lubricant will help to keep the o-ring from drying out and will help to show a dark sealing line when the housing back is properly sealed.
- Keep the area where the o-ring fits and the sealing surface clean.
- Rinse the housing exterior thoroughly in freshwater after each saltwater use. Depress push buttons several times during rinse. Dry with a soft cloth. Dry port to eliminate water spotting.
After several uses in saltwater, soak the housing in a mild soap solution, rinse, and dry.
- Although not recommended, if it is necessary to remove a housing push button, **Do Not** re-use the E-clip. Contact Ikelite for replacement E-clips (part #0319.12).

CAUTION: Never use spray lubricants as the propellant ingredient can cause the plastic housing to crack. **Use only Ikelite lubricant.**

Storing the Housing

When the housing is going to be stored for a prolonged period it should be soaked in a mild soap solution, rinsed, and dried thoroughly. Remove the back and port from the housing. Remove the back and port o-rings, lightly lubricate them and place them in a plastic ziploc bag. Place the plastic bag inside the housing for storage. Operate the push buttons periodically.

Spare Parts

0132.59Spare Main Housing O-ring
0105Spare Port-to-Housing O-ring
5020Silicone Lubricant in 4 1cc Tubes
5512.68O-ring Kit with Main O-ring, Port O-ring, & 1cc Lubricant
0333.6Tray Mounting Screw 12-24 x 1/2 in. Stainless
0212.121/4 in. Shoulder Washer for 12-24 Screw
9104.5Waterproof Bulkhead Cap
0200.91Body Cap

Photo Tips

- The number one rule in underwater photography is to eliminate as much water between the camera and subject as possible. Get as close as you can to the subject, then use the zoom. If you are using flash for still photos, subjects beyond 6 feet (1.8m) will not have much color regardless of strobe power.
- Photograph in clear water; do not stir up the sand or silty bottom. If backscatter becomes a problem in the environment you are photographing, an external flash will help eliminate much of the backscatter.

Photo Tips - continued

- Many digital cameras have a slight lag time between when you press the shutter release button and the camera actually takes the picture. Hold the housing steady a second or two after pressing the shutter release button.
- Do not shoot down on subjects as they will quite often blend into the background and be difficult to see in the photograph. Shoot subjects straight on or shoot up at a slight angle using the blue water as a contrasting background.
- When using daylight or flash, if your camera consistently over or underexposes the image, you may want to adjust your camera's exposure compensation  settings.
- If you error in exposure, it is better to have the image slightly underexposed rather than overexposed. An overexposed image is missing color information which cannot be adjusted in a photo processing program. A slightly underexposed image has color information that can be adjusted.
- It is important to respect all living creatures underwater, including people, marine life, and coral. While we encourage people to get close to their subjects when taking a photograph, they should not touch, lie on, or in any way disturb the things they find underwater.

Technical Support

Please read the troubleshooting section of this instruction manual before contacting Ikelite Technical Support.

Ikelite Technical Support

Email: ikelite@ikelite.com

Phone 317.923.4523

Fax 317.924.7988

Limited Warranty

This Ikelite product is warranted against any manufacturing defects for a period of one (1) year from the original date of purchase. Defective products should be returned to Ikelite postage paid. Ikelite will, at its sole discretion, repair or replace such products, and will return to customer postage paid. All other claims of any nature are not covered. Except as mentioned above, no other warranty expressed or implied applies to this Ikelite product.

Returning Products For Service

Ikelite is most interested in performing any service to ensure that all products perform as intended. Evidence of purchase date must be provided to obtain warranty service.

No prior authorization is required. You may return directly to us or through your dealer. Please include a brief description of the problem, any relevant email correspondence, and/or instructions on what you want us to do. Always include name, shipping address, email address, and phone number inside of the package. Send postage paid to:

*Ikelite Underwater Systems
Attention: Service Department
50 West 33 Street
Indianapolis, IN 46208 USA*

No reimbursements for postage paid will be issued.
You may also want to insure the package.

Returning Products for Service (outside the United States)

For the separate international customs documentation form that you complete to accompany the shipment, please state or designate that the enclosed products were originally manufactured in the USA and are being returned to the manufacturer for repair service. Value of the equipment listed for customs purposes should be zero.

Product Registration

Please go to www.ikelite.com to register your Ikelite housing within 15 days of purchase.



**Ikelite Underwater Systems
50 West 33rd Street
Indianapolis, IN 46208 USA**

www.ikelite.com