

# Ikelite SLR-DC Housing

instruction manual

#6871.35 for Canon EOS Digital RebelXT, 350D



Congratulations on your purchase of an Ikelite Digital Camera Housing. Ikelite has over 40 years of experience in the underwater photographic and lighting market. Our products are designed and built in the USA by Ikelite for both the professional and amateur photographer.

The clear housing permits instant visual inspection of the camera and all sealing surfaces as well as complete monitoring of controls and camera LCD screens.

Ikelite Digital Housings are slightly negative in salt water for stability. This housing has been water pressure tested at the factory. Housing is pressure tested to 200' (60m).

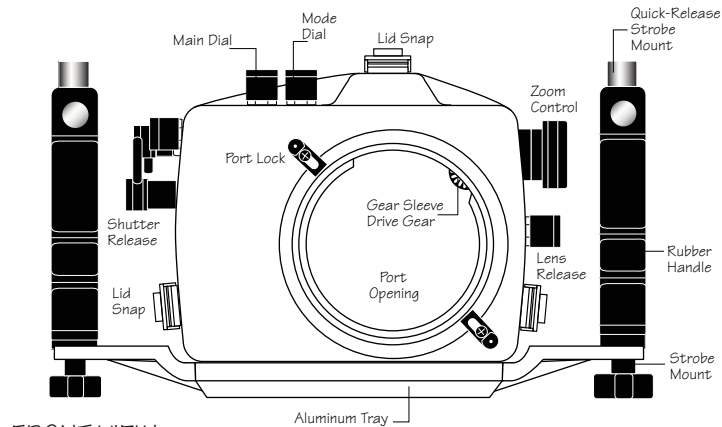

FRONT VIEW

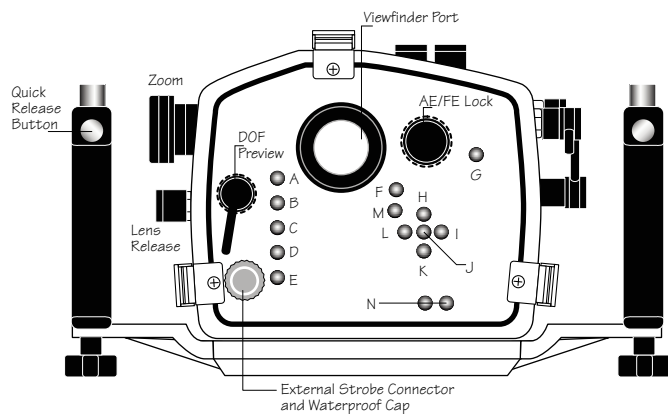

- |          |                    |                     |                   |                               |
|----------|--------------------|---------------------|-------------------|-------------------------------|
| [A] Menu | [D] Playback       | [G] AF Point Select | [J] Set           | [M] Drive Mode                |
| [B] Info | [E] Erase          | [H] ISO             | [K] White Balance | [N] Conversion Circuitry Mode |
| [C] Jump | [F] LCD Illuminate | [I] Cross Key       | [L] Cross Key     |                               |

BACK VIEW

2

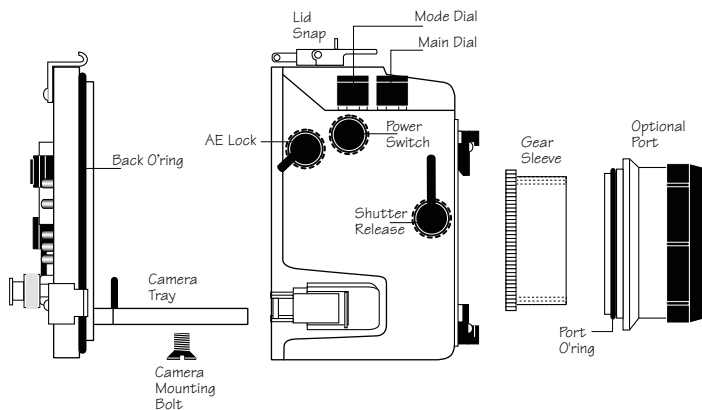

SIDE VIEW

## Installing the Camera

1. Remove the back from the housing. The mounting tray for the camera is secured to the housing back. Position the camera and lens on the tray and secure it with the mounting bolt which threads into the camera's tripod socket. Realign the depth-of-field preview button control.

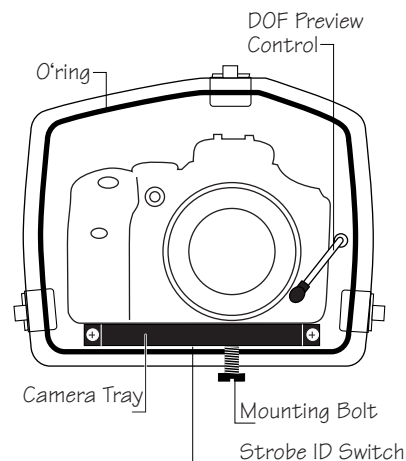

**NOTE:** Strobe ID Switch located on bottom of camera tray.

## Opening the Housing

1. Lid Snaps have a **Lock**. To open, push Lid Snap Lock forward and lift as shown. Keep pressure on the Lid Snap so it does not fly open quickly.

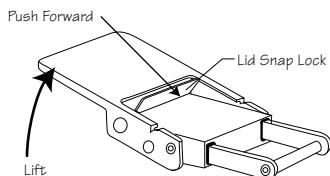

*Some lid snaps have a lot of spring tension once they go over center, have a firm grip on the lid snap. Lid Snaps may be opened one at a time.*

## Setting the Conversion Circuitry Strobe ID Switch.

On the bottom of the camera tray is a switch for setting the DS Substrobe ID. Set the switch to the Model of DS Substrobe being used, SD125 or DS51.

- When using dual strobes of different models such as a DS51 and a DS125, set the ID switch to DS51.

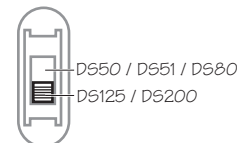

Front of Camera/Tray

## Flash Connection for External Strobes

When using an external strobe connect the housings Hot Shoe Connector, slide the connector into the hot shoe of the camera from the back of the camera as shown. Slide the connector forward until it stops. This can be done after the camera is secured with the mounting bolt.

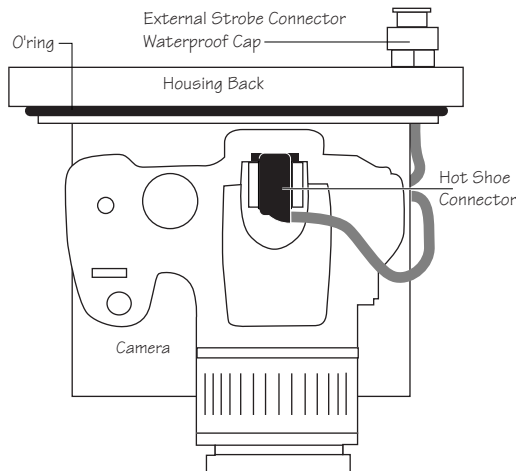

### Caution:

Do not remove the External Strobe Connector's waterproof cap unless an external sync cord is going to be plugged in.

## Installing Camera in Housing

Before installing the camera, pull out on the controls in the front section of the housing. This will allow the camera to slide in easier. Once the camera is installed and the lid snaps have been closed, return the controls to their operating position.

5

## Preparing to Install Zoom Clamp & Gear Sleeve

Determine the type of lens being used on the camera.

Type 1 Lenses have a lens opening that is NOT larger in diameter than the zoom ring. (Fig. 1).

Type 2 Lenses have a lens opening that IS larger in diameter than the zoom ring. (Fig. 2).

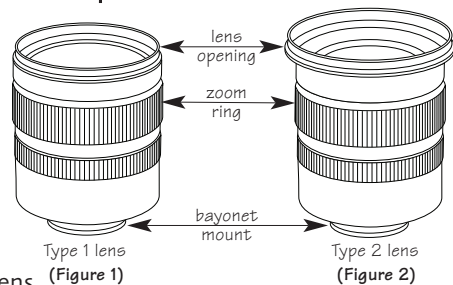

## Zoom Clamps & Gear Sleeves Included with Housing

There are 2 different Zoom Clamps and Gear Sleeves provided with the housing. Start with the suggested Zoom Clamp and Gear Sleeve depending on the Type of lens being used. See (Fig. A or B)

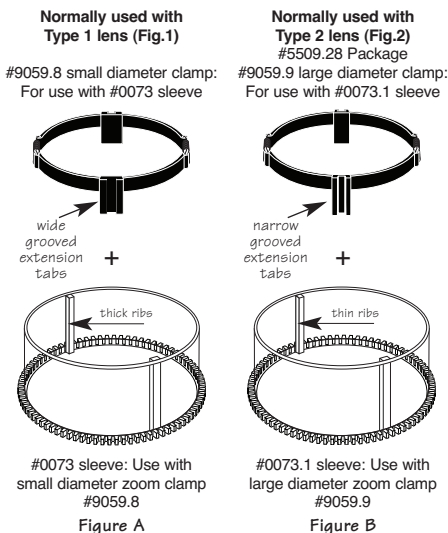

7

## Closing the Housing

1. Place housing face down in your lap.
2. Check to see that there is an o'ring on the housing back and that it is clean and in its proper location.
3. Guide the back onto the housing. The o'ring should touch the housing all the way around. There should be an even gap all the way around between the housing and the housing back.
4. Lift the lid snaps so they are extended and place the lid snap into the hook on the housing back.
5. To close the housing push down on the lid snaps until they snap into place. Lid snaps on opposite sides of the housing should be closed at the same time. Be sure they are down far enough to engage the lock.

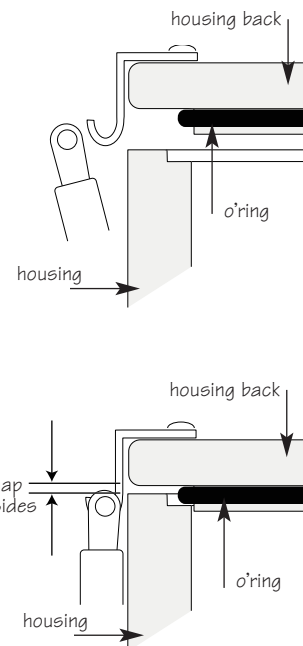

### Double check

Once the housing is closed, check the o'ring seal. Check the gap between the housing back and the housing, it should be even all the way around.

Look through the clear plastic back at the o'ring. You should see a darkened area where the o'ring is compressed against the housing back. If you do not see an even black compression seal all the way around the back, open the lid snaps, reseal the housing back and close the lid snaps. Visually check the seal again.

6

## Installing the Zoom Clamp & Gear Sleeve On the Type 1 Lenses

### Installing the Zoom Clamp

The Zoom Clamp has springs so it can be expanded to fit over the Zoom ring of the lens as shown in (Fig. C). Install the Zoom Clamp with the extension tabs toward the rear element of the lens. After installing the Zoom Clamp, check that when rotating the Zoom Clamp it rotates the Zoom ring on the lens. If the Zoom Clamp is not tight enough to rotate the Zoom ring on the lens, remove the Zoom Clamp and install the rubber strips (supplied) to the inside of the Zoom Clamp as shown (Fig. F). Two thicknesses of rubber strips are provided. Start by installing the thinnest rubber strips, if the Zoom Clamp still is not tight enough use the thicker rubber strips. Reinstall the Zoom Clamp.

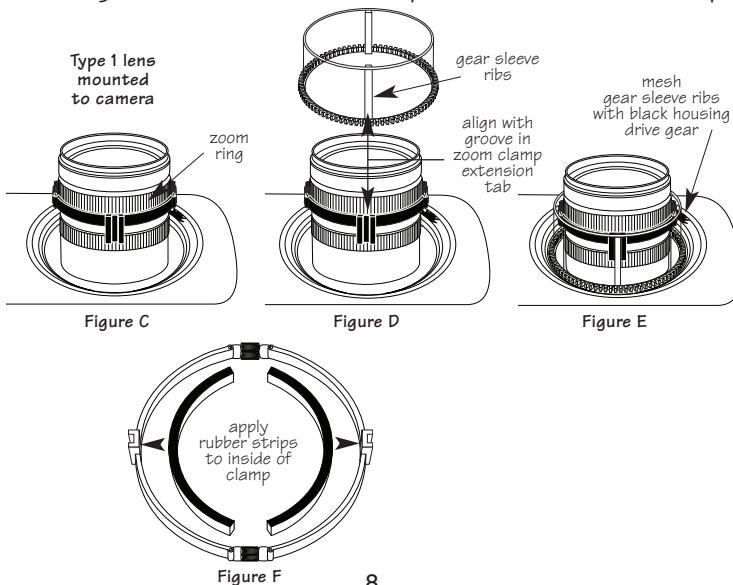

8

## Install the Gear Sleeve

After the Zoom Clamp is installed, lower the appropriate Gear Sleeve over the Zoom Clamp aligning the Gear Sleeve ribs with the grooves in the Zoom Clamps extended tabs as shown (Fig. D & E). Note that the ribs of the Gear Sleeve should slide freely in the grooves of the Zoom Clamp. If the Gear Sleeve does not slide freely, remove any rubber strips on the inside of the Zoom Clamp, if no rubber strips are installed then try using the Zoom Clamp and Gear Sleeve for Type 2 lenses in the #5509.28 package.

Lower the Gear Sleeve into the port opening of the housing so the teeth on the Gear Sleeve mesh with the teeth on the housing Drive Gear (Fig. G). When the port is installed it will lock the Gear Sleeve in place. After installing the port, rotate the housings Zoom Control Knob to see that the Gear Sleeve is properly rotating the lenses Zoom ring.

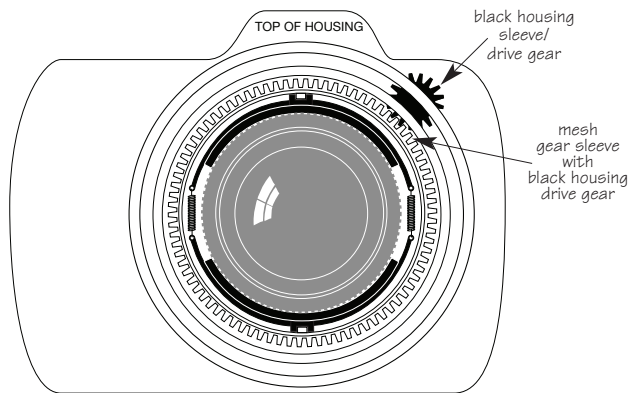

Figure G

9

## Installing the Gear Sleeve

After the Zoom Clamp is installed.

Place the Gear Sleeve in the port opening of the housing (Fig. I). Lower the lens through the Gear Sleeve, aligning the grooves in the Zoom Clamp with the ribs on the Gear Sleeve. Note that the ribs of the Gear Sleeve should slide freely in the grooves of the Zoom Clamp. If the Gear Sleeve does not slide freely, remove any rubber strips on the inside of the Zoom Clamp (Fig. H) or use thinner rubber strips. Reinstall the Zoom Clamp on the lens and lower the lens through the Gear Sleeve, aligning the grooves in the Zoom Clamp with the ribs on the Gear Sleeve. Remount the lens to the camera body, make sure the lens is locked into the camera body. Position the Gear Sleeve teeth so they mesh with the housing drive gear (Fig. J). When the port is installed it will lock the Gear Sleeve in place. After installing the port, rotate the housings Zoom Control Knob to see that the Gear Sleeve is properly rotating the lenses Zoom ring.

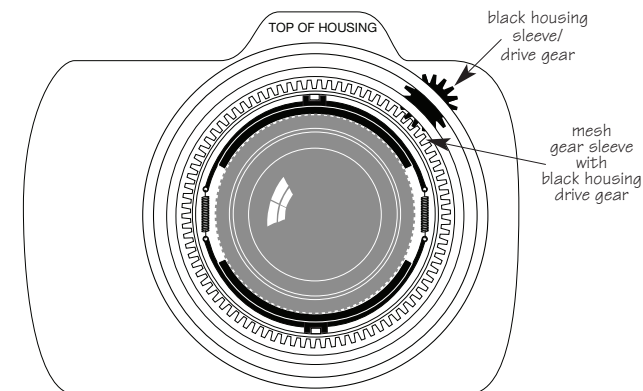

Figure J

11

## Installing the Zoom Clamp & Gear Sleeve On Type 2 Lenses

Due to the larger diameter of lens opening on Type 2 lenses, the Zoom Clamp and Gear Sleeve need to be installed from the rear (bayonet end) of the lens. Use the housings Lens Release Control and remove the camera lens from the camera body.

### Installing the Zoom Clamp

The Zoom Clamp has springs so it can be expanded to fit over the Zoom ring of the lens as shown in (Fig. I). Install the Zoom Clamp with the extension tabs toward the rear element of the lens. After installing the Zoom Clamp, check that when rotating the Zoom Clamp it rotates the Zoom ring on the lens. If the Zoom Clamp is not tight enough to rotate the Zoom ring on the lens, remove the Zoom Clamp and install the rubber

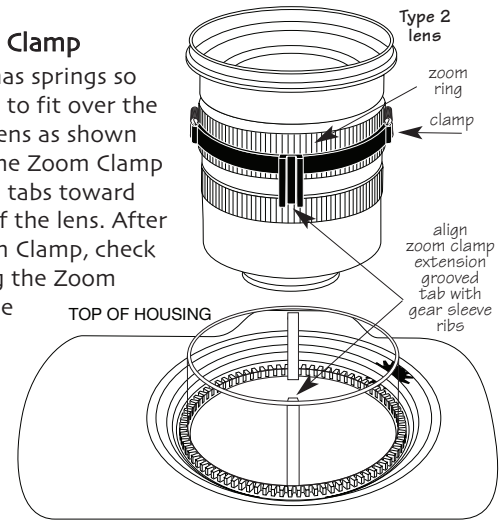

Figure I

strips (supplied) to the inside of the Zoom Clamp as shown (Fig. H). Two thickness of rubber strips are provided. Start by installing the thinnest rubber strips, if the Zoom Clamp still is not tight enough use the thicker rubber strips. Reinstall the Zoom Clamp.

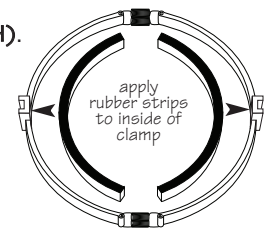
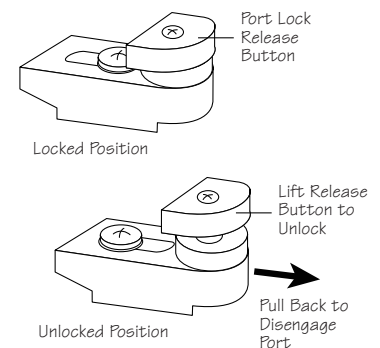

Figure H

10

## Installing the Port

There are two port locks on the front of the housing. (See housing front) Each port lock has a Release Button, lift the release button and slide each Port Lock away from the port opening. In the unlocked position the Release Button will remain in the up position as shown.



To prepare the port for installation, remove the port o'ring and lightly lubricate it. The port seal is a side-to-side seal and requires the o'ring to be lightly lubricated for easy installation. Put a small amount of lubricant on your fingers and draw the o'ring through your fingers to lightly lubricate it. Do not stretch the o'ring. Check that the lip of the port where the o'ring fits and the sealing surface on the housing are clean. Place the port, with o'ring into the housing's port opening. Press down on the port firmly and evenly until you feel the port slide into place. Continue to push down on the port and push each port lock forward until it clicks into place. It may help to slightly rotate the port as you push in on the port lock. When the port lock clicks into place the Release Button will drop down against the port lock.

Check around the perimeter of the port seal to see that the o'ring is properly sealed and not extruded.

12

## Installing the Port cont.

### To Remove Port

To remove the port lift up on each Release Button and slide the port lock away from the port.

### Port Seal Inside View

If the port is installed before the camera is inserted into the housing, look on the inside of the housings at the port seal. Check to see that the o'ring is properly sealed as shown in figure 1 and not extruded as shown in figure 2.

Fig. 1

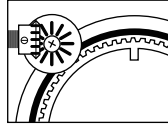
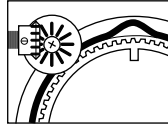

Fig. 2



#### Caution:

After installing the port, turn the Zoom Control knob on the housing. If the Zoom Control is difficult to turn, the gear sleeve may be warped. If so reduce or omit any rubber installed on the Zoom Clamp. (Fig.H on pg.11). *If the Zoom Clamp is still warped, use of the #5509.28 package may be required. (See page 7)*

13

## Using External Strobes

This housing has Conversion Circuitry built into the camera tray. When used with Ikelite DS Substrobes the Conversion Circuitry provides real Canon eTTL flash exposure with over and under-exposure compensation of two f-stops in half-stop increments.

The Conversion Circuitry also offers Manual exposure control with 3 1/2 f-stops of under-exposure control in 1/2 stop increments.

The Conversion Circuitry is powered by the Ikelite DS Substrobe when connected to the housing with the #4103.51 single or #4103.52 dual sync cord.

See page 12 for DS Substrobe compatibility with the Conversion Circuitry.

14

## Using External Strobes Cont.

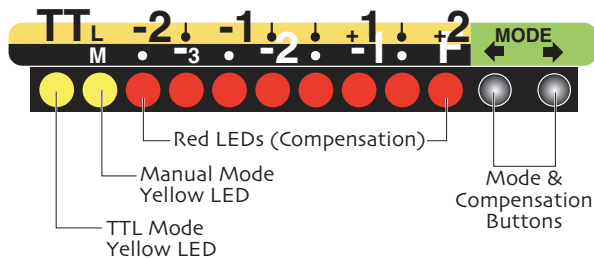

### Using the Conversion Circuitry (Set DS Substrobe to TTL mode)

#### • Mode and Compensation Buttons

The Conversion Circuitry default is set to TTL. To switch between TTL and Manual Modes depress both Mode Buttons at the same time and keep them depressed until you see the desired Yellow LED Mode illuminate.

• **TTL Mode** (indicated when the yellow LED directly below TTL is illuminated). TTL Mode is the default setting. When the DS Substrobe is powered ON the yellow TTL LED will illuminate. None of the Red LEDs will illuminate. This indicates that NO (+) plus or (-) minus compensation is selected. Depress the Mode buttons to select +/- compensation. Note that the TTL +/- compensation values are in the yellow bar with the heading TTL.

• **Manual Mode** (indicated when the yellow LED directly below the M is illuminated). When the Manual Mode is selected the Red LED directly below the F (full power) will illuminate. Note that the Manual minus (-) compensation values are in the black bar with the heading M. (Set DS Substrobe to TTL mode)

15

### NOTE: DS Substrobe Up-date may be required.

#### DS50 Substrobes

- DS50 SubStrobes with a Serial Number below 63,850 can not be updated to operate with the eTTL Conversion Circuitry.
- DS50 SubStrobes with a Serial Number between 63,850 and 69,999 operate with the eTTL Conversion Circuitry, but require update to provide optimum performance.
- DS50 Substrobe with a Serial Number of 70,000 or higher or with one of the two following labels in the battery compartment provide optimum performance with the eTTL Conversion Circuitry.

#### DS125 Substrobes

- DS125 SubStrobes with a Serial Number below 2,500 must be updated to operate correctly with the eTTL Conversion Circuitry.
- DS125 SubStrobes with a Serial Number between 2,501 and 4,900 operate with the eTTL Conversion Circuitry but require update to provide optimum performance.
- DS125 Substrobe with a Serial Number of 5,000 or higher or with one of the two following labels in the battery compartment provide optimum performance with the eTTL Conversion Circuitry.

#### For Substrobe Up-Date:

Contact Ikelite for information.



16

## Using External Strobes Cont.

### Using Ikelite Non-DS Substrobes (Substrobe 50, 100A, 200, 400) with this Housing.

The Conversion Circuitry is automatically disabled when used with a Non-DS Substrobe. These Substrobes can be used in their manual mode utilizing any power settings provided on the Substrobe.

### Using Non Ikelite Strobes with this Housing.

The Conversion Circuitry is automatically disabled when used with a Non Ikelite Strobe. These strobes can be used in their manual mode utilizing any power settings provided on the strobe.

17

## Pre-Dive Your System

It is recommended that you take the complete system into a swimming pool before use in open water. This will give you a chance to become familiar with the handling and operation of your housing and strobe(s).

## Optional Accessories

### Lead Weight #0906.58

The buoyancy of the system will depend on the size and number of strobes used as well as the weight of the camera. Ideally the system should be slightly negative in the environment in which it will be used. If you need to add weight to the system, an optional lead weight is available. To add the lead weight remove the (2) screws from the bottom of the aluminum tray. Place the lead weight into the pocket of the aluminum tray and reattach.

### Ikelite Lube #0184.1

### Port O'ring #0105

### Housing Back O'ring #0132.59

While both the Port and Back o'rings should last quite some time it is best to carry a spare in case one becomes damaged or lost.

## Storing the Housing

When the housing is going to be stored for a prolonged period it should be soaked in a mild soap solution, rinsed and dried thoroughly. Remove the back and port from the housing. Remove the back and port o'rings, lightly lubricate them and place them in a plastic zip-lock bag. Place the plastic bag inside the housing for storage. Operate the push buttons periodically.

19

## Strobe Arms

This housing offers two types of arm mounting systems. The top of the rubber handles utilize Ikelite's Quick-Release Arm, available with the SA-100R Arm system.

The bottom of the rubber handles have a wing nut that accepts the Ikelite Tray Mount. The Tray Mount comes with the Ikelite SA-125 Arm system and the SA-100T Arm system.

## Lubricants

1. Ikelite provides silicone lubricant with the housing. We recommend that you use only Ikelite lubricant as some other brands may cause the o'ring to swell and not seal properly.
2. Use only enough lubricant to lightly cover control shafts and o'rings. Wipe off any excess lubricant with a clean cloth. Lubricant is not a sealant, it is used to reduce friction. Excessive lubricant can collect sand and dirt which may interfere with proper sealing.

## CAUTION

**Never use spray lubricants as the propellant ingredient can cause the plastic housing to crack.**

18

## Port Information

While we have included a list of our ports and a short list of Canon Lenses and port recommendations we suggest visiting our web site for the latest information on lenses and port recommendations.

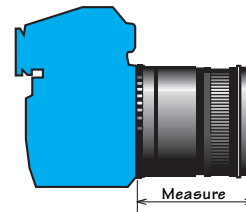

- With the lens on the camera extended to full length, measure from front of camera to face of lens.
- Select the appropriate port based on the lens type and length.
- Maximum lens diameter accommodated is 8.4cm (3.3")
- Maximum lens diameter when using zoom or focus clamp 7.1cm (2.8")

## Choosing a Port

### DOME PORT

#5503.....Wide angle 28mm to 17mm or lens up to 7.6cm (3") in length

#5503.20 ..Nikon 18 & 20mmD lenses

#5503.50 ..Lens 7.6-10.1cm (3-4")

#5503.55....Lens 8.9-11.4cm (3.5-4.5")

#5503.80 ..Lens 10.1-12.7cm (4-5")

#5503.81....Nikkor 28-105mm lens only

#5503.85 ..Lens 12.7-15.2cm (5-6")

*Some zoom lenses may require the addition of a +diopter close-up lens. (Available from camera store).*

### SUPERWIDE DOME PORT

Superwide lens 110° to 170°. Not compatible with the SLR-MD housing due to vignetting.

#5503.15 .....Lens up to 6.3cm (2.5")

20

## Ports Continued

### FLAT PORT

For standard, macro, and telephoto lenses.

Due to refraction flat ports reduce the angle-of-coverage of a lens and at the same time enlarge the image. This makes the flat port ideal when using standard, macro or zoom lenses to shoot small subjects. Note that if a port is long enough to accommodate the full length of a 1:1 macro lens, the lens may vignette when used at infinity. If access to the lens' full range is desired, then select a dome port instead.

### FLAT PORT

- #5501 . . . . Lens up to 6.3cm (2.5")
- #5502 . . . . Lens 6.3-8.9cm (2.5-3.5")
- #5502.41 . . . Lens 7.9-10.4cm (3.1-4.125")
- #5505 . . . . Lens 8.9-11.4cm (3.5-4.5")
- #5505.45 . . . Lens 10.4-13cm (4.1-5.125")
- #5505.5 . . . Lens 11.4-14cm (4.5-5.5")
- #5505.58 . . . Lens 13-15.5cm (5.1-6.125")

### FLAT PORT WITH FOCUS

For long lenses whose focus collar extends beyond the housing focus. Telephoto lenses longer than 135mm are not recommended.

- #5506 . . . Lens 8.9-11.4cm (3.5-4.5")
- #5506.5 . . . Lens 11.4-14cm (4.5-5.5")
- 5507 . . . . Lens 14-16.5cm (5.5-6.5")
- 5508 . . . . Lens 16.5-19cm (6.5-7.5")
- 5508.05 . . . . Nikon 105mm lens only

## Maintenance

The Ikelite Housing should be given the same care and attention as your other photographic equipment. In addition to normal maintenance we recommend that the housing be returned to Ikelite periodically to be checked and pressure tested.

1. **Do Not** leave the camera and housing in direct sunlight for prolonged periods. Heat may damage the camera.
2. **Do Not** ship the camera in the housing.
3. Before using the housing, always check the tightness of the **set screw** in each control knob.

Check each **control gland** penetrating the housing to make sure they are tight. There is a slight chance that either could vibrate loose during travel.

4. Keep the back and port o'ring clean and lightly lubricated. To lubricate remove the o'ring from the back. Put a small amount of Ikelite lubricant on your fingers. Draw the o'ring through your fingers to apply a light coating of lubricant. Only apply enough lubricant to make the o'ring feel slick. **Do Not stretch the o'ring.** This light coating of lubricant will help to keep the o'ring from drying out and will help to show a dark sealing line when the housing back is properly sealed.
5. Keep the area where the o'ring fits and the sealing surface clean.
6. Rinse the housing exterior thoroughly in fresh water after each salt water use. Depress push buttons several times during rinse. Dry with a soft cloth. Dry port to eliminate water spotting. After several uses in salt water soak the housing in a mild soap solution, rinse and dry.

**CAUTION:** Never use spray lubricants as the propellant ingredient can cause the plastic housing to crack.

## Lens & Port Recommendations

Canon Lenses	Dome	Flat Port	Flat Port w/Focus
14mm EF 1:2.8	5503 (1)		
15mm Fisheye	5503.15		
20mm	5503		
24mm	5503		
28mm	5503	5501	
35mm	5503	5501	
50mm Macro 1:2.8	5503.50	5505	
100mm Macro	NR	5505.58	
100mm EF Macro 1:2.8	NR	5505.58(4)	
100mm USM Macro 1:2.8	NR	5505.45	5508.45
16-35mm USM	5503.55(2)		
17-35 Ultrasonic	5503.50 (2)		
17-40mm USM	5503.50(2)		
18-55 EF-S	5503		
*20-35mm	5503.50		
*20-35 Ultrasonic	5503 (2)		
*22-55 Ultrasonic	5503.50(2)		
*24-85mm	5503.50		
*28-70mm	5503.85 (3)		
*28-80mm	5503.50		
*28-80mm USM	5503.50(2)		
28-105mm EF USM II	5503.55(2)		
*28-105mm USM	5503.80(2)		
*35-80mm	5503	5502	
*35-135mm	5503.80		
<b>Sigma AF (Canon)</b>	<b>Dome</b>	<b>Flat Port</b>	
*28-105mm f/2.8-4	5503.80(2)		

(\*) Zoom lenses that do not focus to 12" require a +4 diopter close-up lens be added to the lens when used underwater behind a dome port.

- (1) Port shade may have to be removed to avoid vignetting.
- (2) Lens requires special zoom clamps and focus sleeve #5509.28.
- (3) Lens diameter does not allow zoom operation in the housing.
- (4) Auto or Manual focus must be selected before closing the housing. Requires special zoom clamp and focus sleeve #5509.28 for manual focus.

## Control Maintenance

Ikelite controls are designed to provide years of reliable service with minimal maintenance.

1. Push button controls require no maintenance other than rinsing in fresh water after saltwater use. If a push button control becomes difficult to push or if it sticks when depressed, soak the housing in luke warm fresh water. After a few minutes operate the push button. If this does not correct the problem, return the housing to Ikelite for maintenance.
2. Some of the controls have long shafts. These controls can be

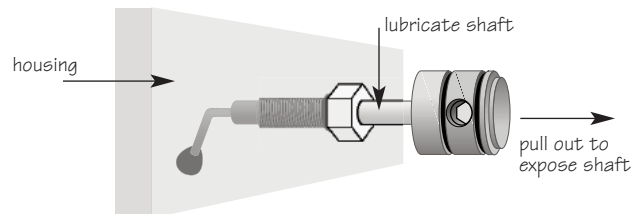

pulled out, exposing the shaft (see drawing).

To lubricate the control, gently pull on the knob until the stainless steel shaft is exposed. Lightly lubricate the shaft, then move the shaft in and out several times. This will lubricate the x'ring in the Ikelite control gland. This should be done before using the housing after a prolonged storage period, or once a week when the housing is in use.

- Some of the controls have a short shaft and cannot be pulled out exposing the shaft for lubrication. In the unlikely event one of these controls sticks or becomes difficult to operate you can remove the control from the housing and lubricate it, or return the housing to Ikelite for maintenance. To remove the control, loosen the set screw in the knob (allen wrench required); remove the knob. If there is salt or dirt build-up on the exposed control shaft, clean the shaft. Open the housing and gently slide the control shaft out of the control gland. Clean and lightly lubricate the shaft, including the end of the shaft. Slide the shaft back into the control gland and gently slide it back and forth a few times without fully removing the shaft from the gland. Replace the knob, NOTE the flat area on the shaft, the set screw in the knob should tighten down against the flat area on the control so the knob does not turn on the shaft.

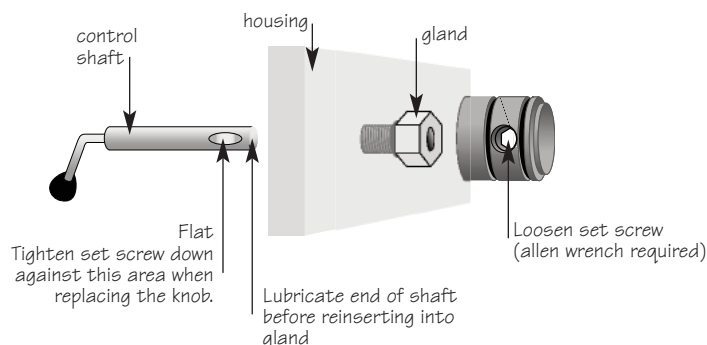

25

## General Tips

- You should completely assemble and test your set-up in a swimming pool before using it in openwater.
- It is a good idea to start each photo dive with a fully charged battery(s) in the camera and strobes.
- As soon as you enter the water, take a moment and check the housing to see that it is properly sealed.
- Next, check to see if there are any bubbles on the face of the port. If there are, take your finger and remove them. If there are bubbles on the lens port they can produce soft focus spots in your photographs.
- Set Image Resolution to the Highest JPG format available or RAW. Higher resolution settings are required for printing. High resolution images can easily be reduced in size with software and retain their original quality. A Low resolution image can be enlarged with software but much of the quality will be lost.
- Digital images are usually transferred to the computer where their appearance can be fine tuned. Many of the image manipulation programs make you think you can magically correct any image taken and make a good picture. One thing to be aware of is that if an image is overexposed that some of the color information in the file is missing. If the color is missing you cannot adjust it. If images are underexposed the color and detail may be there, it is just dark, and you can adjust it to some degree. So if you error in exposure it is better to have the image slightly underexposed than overexposed.

26

## Photo Tips

- The number one rule in underwater photography is eliminate as much water between camera and subject as possible. Get as close as you can to the subject, then use the zoom. If you are using flash, subjects beyond 6 feet (1.8m) will not have much color.
- Digital cameras have a slight lag time between when you press the shutter release button and the camera actually takes the picture. It only takes a slight amount of pressure to trip the shutter, if the shutter doesn't trip immediately don't push down harder on the shutter control as you may damage the camera. Hold the camera steady a second or two after pressing the shutter release button.
- Do not shoot down on subjects as they will quite often blend into the background and be difficult to see in the photograph. Shoot subjects straight on or shoot up at a slight angle using the blue water as a contrasting background.
- Underwater flash is used to restore the warmer colors filtered out by the water as well as to illuminate the subject.
- For balanced lighting meter the background and set the camera aperture accordingly. Use TTL, adjust the strobe's power settings, or move the strobe closer or farther away to properly expose the subject with the chosen camera aperture.

27

## Ikelite Limited Warranty

All Ikelite products are warranted against any manufacturing defects for a period of one year from the date of purchase. Defective products should be returned prepaid to Ikelite. Ikelite will, at its discretion, repair or replace such products, and will return to customer prepaid. All other claims, of any nature, including but not limited to bulb failure are not covered. Except as mentioned above, no other warranty expressed or implied, applies to this Ikelite product.

## Returning Products for Service

Ikelite is most interested in performing any service to assure that all products perform as intended. For repair or service, return the product to the address below with your name, address, phone number and a brief description of the problem. Evidence of purchase date must be provided to obtain warranty service.

Ikelite Underwater Systems  
50 W 33rd Street  
Indianapolis, IN 46208 USA

317-923-4523

email: [ikelite@ikelite.com](mailto:ikelite@ikelite.com)  
[www.ikelite.com](http://www.ikelite.com)

Digital 6871.35-03-0306