

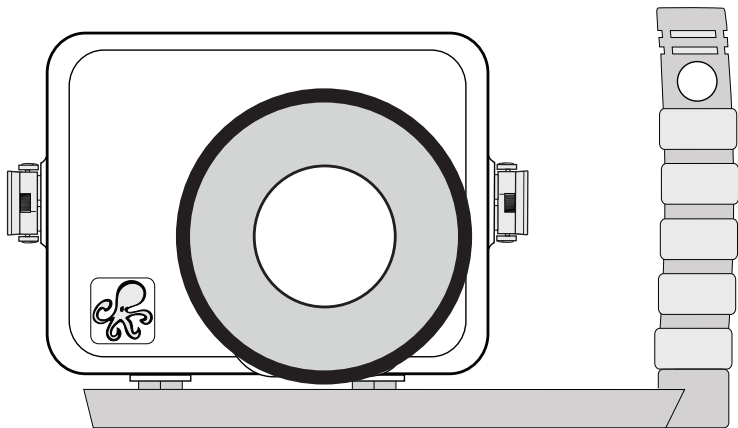

# Digital Housing instruction manual 6139.02 for Olympus XZ-2



Thank you for your purchase of Ikelite equipment. Please read this instruction manual completely before attempting to operate or dive with this product. Please refer to the back page of this manual to register your Ikelite product.

## Table of Contents

<b>Specifications</b> .....	P. 4
<b>Package Contents</b> .....	P. 4
<b>Preparation</b> .....	P. 4
Initial Camera Setup .....	P. 5
Attach External Tray and Handle to Housing .....	P. 6
Parts of the Housing - Front View .....	P. 7
Parts of the Housing - Back View .....	P. 8
Opening the Housing .....	P. 9
Installing the Camera .....	P. 9
Attach Hotshoe to Camera .....	P. 9, 10
Attach Camera to Mounting Tray .....	P. 9, 10
Using the Camera's Built-in Flash .....	P. 11
Closing the Housing .....	P. 11
<b>Usage</b> .....	P. 12
Final Check .....	P. 12
Zoom Control .....	P. 12
Diffuser and Deflector Installation and Use .....	P. 13
Conversion Circuitry .....	P. 14
Attaching an Ikelite Strobe Arm to the Housing Handle ..	P. 14
Attaching a Sync Cord to the Housing .....	P. 15
Turn Camera On .....	P. 15
Entering the Water .....	P. 16
<b>Maintenance</b> .....	P. 16
Lens Port .....	P. 16

## Table of Contents - continued

Lubricant .....	P. 16
O-ring Storage .....	P. 16
Housing Maintenance .....	P. 17
Control Maintenance .....	P. 18
<b>Photo Tips</b> .....	P. 20
<b>Troubleshooting</b> .....	P. 20
<b>Replacement Parts</b> .....	P. 24
<b>Recommended Accessories</b> .....	P. 24
<b>Customer Support</b> .....	P. 26
<b>Limited Warranty</b> .....	P. 26
<b>Returning Products for Service</b> .....	P. 27
<b>Product Registration</b> .....	Back Cover

## Specifications

Width .....	7.4 in. (188mm) including controls
Height .....	6.0 in. (152mm) including controls
Depth .....	6.2 in. (157mm) including controls and lens port
Weight .....	4.1lb (1.9kg)
Buoyancy .....	Slightly negative in saltwater for stability

## Package Contents

- Ikelite Digital Housing
- Silicone Lubricant
- Vinyl Port Cover
- Diffuser
- Deflector
- Extra Control Tips

## Preparation

This product has been water pressure tested at the factory and is depth rated to 200 ft. (60m). Thoroughly inspect and immerse the empty housing completely in water before installing a camera. If any fogging occurs or droplets of water enter the housing, do not install a camera. Clean the housing main o-ring and retest to make sure that it is watertight. Refer to the Troubleshooting section, page 21.





Please read your Canon camera manual thoroughly to have a full understanding of each camera function.

If you are new to underwater photography, be sure to read the Photo Tips section.

## Initial Camera Setup (before placing camera in housing)

- Insert a fully charged battery. Due to the power required to operate the camera and LCD screen, start each dive with a fully charged camera battery.
- Insert and format a SD or SDHC memory card.
- Set camera date and time.
- Set Mode Dial to “M” Manual. Set Shutter speed to 1/60th second or faster for moving subjects. Set Aperture to F1.8 when NOT using an underwater strobe, otherwise set aperture to F4.0. These settings are a good starting point for most underwater shooting situations.
- Raise Camera Flash and set Flash Mode to “Fill-In”  .
- Set IS1 to “Auto.”
- Set White Balance to “WB Auto” AUTO.

For more accurate colors, we recommend setting manual white balance underwater using a white slate or white sandy bottom. Manual white balance should be reset for each working depth due to color absorption caused by the water. When adding a UR-Pro color filter, reset manual white balance.

- Set Shooting Mode to “Single”  .
- Set Resolution to “LF” or “RAW.”
- Set Metering to “Ctr-Weighted”  .
- Set Focus Mode to “S-AF” Single AF.
- Set ISO sensitivity to “100.”
- Set Face Priority to “OFF” and ND Filter to “OFF.”
- Set Rec View to “5sec.”
- This housing provides TTL conversion circuitry for automated flash when using Ikelite DS series substrobes.
- To adjust the flash exposure, use the flash exposure compensation   function in the camera.

## Attach External Tray and Handle to Housing

Using a 9/16" open end or socket Wrench (*not supplied*), tighten the External Tray to the Housing Base using the two 3/8-16 Nuts supplied in the accessory package; tighten Nuts firmly.

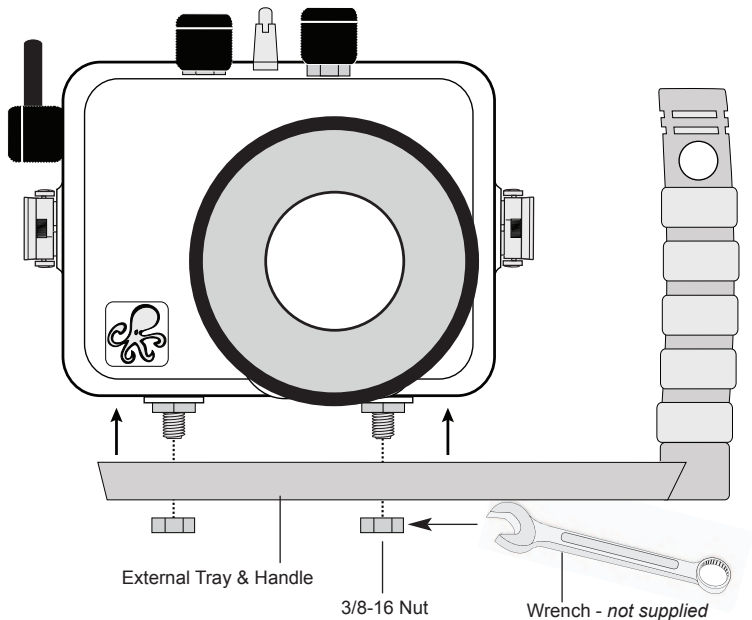



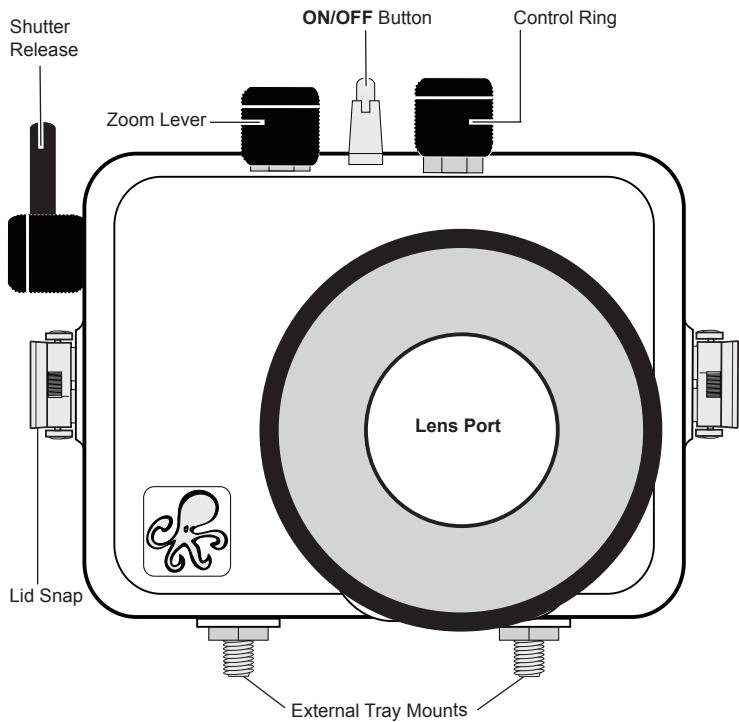

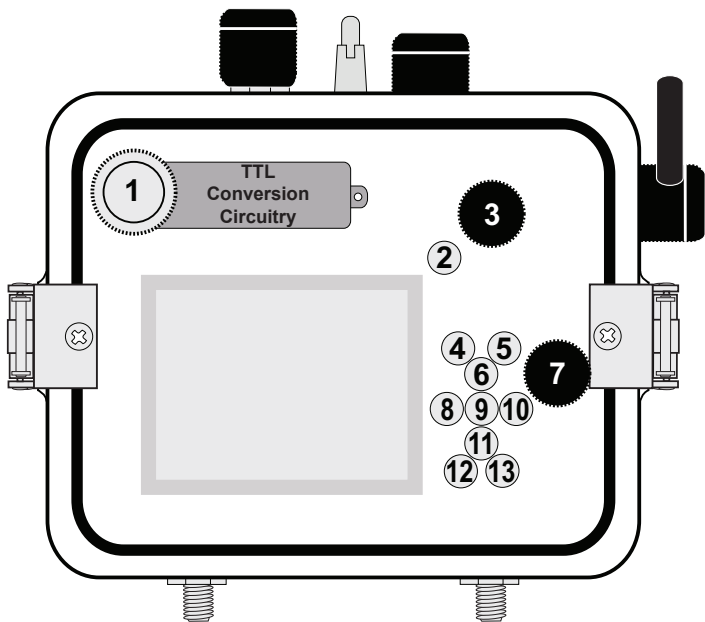

## Parts of the Housing - Front View



## Parts of the Housing - Back View



1. External Strobe Connector & Cap
2.  Movie Button
3. Mode Dial
4.  Playback Button
5. Fn1 Button
6.  Up / Exposure Comp.
7. Sub dial
8.  Left / AF Target Button
9.  OK Button
10.  Right / Flash Button
11.  Down / Erase / Self-timer
12. MENU Button
13. INFO Button



## Opening the Housing

Lid Snaps have a **Lock**.

To open housing, push Lid Snap Lock forward and lift as shown.

Keep pressure on the Lid Snap so it does not fly open quickly.

*Some Lid Snaps have a lot of spring tension once they go over center, so keep a firm grip on the Lid Snap.*

*Lid Snaps may be opened one at a time.*

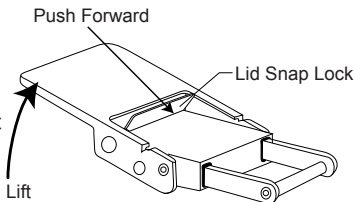

## Installing the Camera

1. Pull out on each housing control until it stops. This will get the controls out of the way for installation of the camera.
2. Remove the back from the housing.
3. Remove camera lanyard from camera if attached.
4. The mounting tray for the camera is secured to the housing back. Position the camera on the tray.
5. Slide the housing Hotshoe Connector into the Camera Hotshoe Mount - page 10, diagram A. Slide the connector forward until it stops. This should be done **before** the camera is secured with the mounting bolt - page 10, diagram B.
6. Using a coin or screwdriver (preferred), secure the camera with the Tray Mounting Bolt which threads into the camera's tripod socket - page 10, diagram B.

## Attach Hotshoe to Camera

Diagram A

External Strobe Connector  
& Waterproof Cap  
(Do not remove underwater)

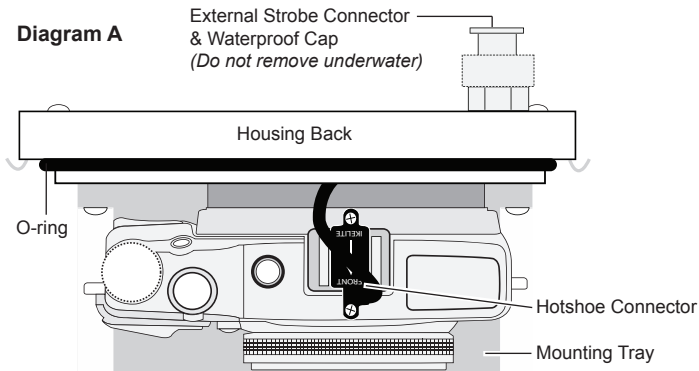

## Attach Camera to Mounting Tray

Diagram B

### CAUTION:

*Do not cross thread or overtighten the Tray Mounting Bolt as you may damage the camera tripod socket threads.*

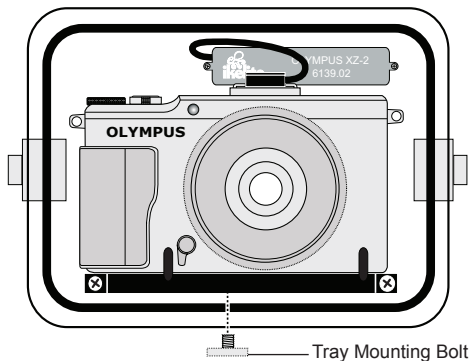

## Using the Camera's Built-in Flash

Extend the camera flash **before** closing the housing. When the camera lens is set to the widest angle setting, you may need to zoom the lens slightly or a dark area (vignetting) may appear in a corner(s) of your photographs. The lens port will block some of the flash. Install the Diffuser and zoom in to eliminate any dark areas noted in your photographs. The lens port will block some of the flash. Install the Diffuser and zoom in to eliminate any dark areas noted in your photographs (*You can test this above water*). See Diffuser/Deflector Installation - page 13. For the best results, we recommend using an external Ikelite Substrobe.

The camera's built-in flash should NOT be used with optional Wide Angle or Accessory lenses.

## Closing the Housing

1. Place housing face down in your lap or on a flat surface.
2. Check to see that there is an o-ring on the housing back and that it is clean and in its proper location.
3. Make sure the camera flash is extended.
4. Guide the back into the housing front. The o-ring should touch the housing all the way around. There should be an even gap all the way around between the housing and the housing back.
5. Lift the lid snaps so they are extended and place each lid snap into the corresponding hook on the housing back.
6. To close the housing, push down on the lid snaps until they snap into place. Lid snaps on opposite sides of the housing should be closed at the same time. Be sure they are down far enough to engage the lock.

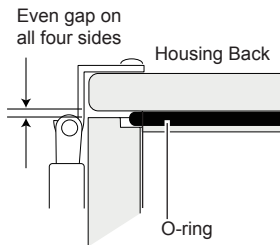
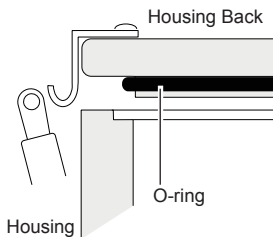

## Usage

### Final Check

Once the housing is closed, check the o-ring seal. Check the gap between the housing back and the housing. It should be even all the way around the housing.

Look through the clear plastic back at the o-ring. You should see a darkened area where the o-ring is compressed against the housing back. If you do not see an even black compression seal all the way around the back, open the lid snaps, reseal the housing back and close the lid snaps. Visually check the seal again.

### Zoom Control (lever type only)

After you have used the housing's zoom control, it must be returned to the center position to disengage. If the housing zoom control is pushing the zoom lever in either direction, you may not be able to take a picture or access other functions. This is because the camera is receiving a signal from the engaged zoom control.



Zoom Control  
"Disengaged"  
(Center Position)



Zoom Control  
"Engaged"

## Diffuser and Deflector Installation

A Diffuser and Deflector are included with the housing. The Diffuser is white transparent plastic. The Deflector is also white but is not transparent.

To install the Diffuser or Deflector, push the “Cut-out” Section over the port and into the port groove until it stops.

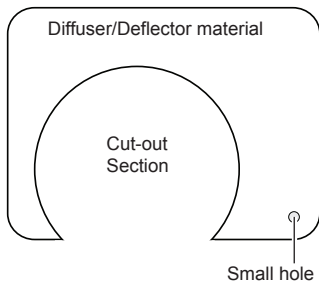

Note the Small Hole. To avoid losing the Diffuser or Deflector, you can attach a fishing line or string to this hole.

Diffuser/Deflector properly installed in port groove

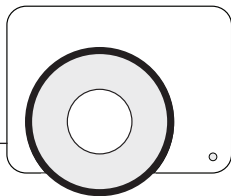

## Diffuser Use

The Diffuser should be installed when using the camera flash. When shooting close-up photographs with the camera flash and at the camera lens's widest angle setting, the lens port on the housing can block a portion of the light from the camera flash. This can result in a shadow in a lower corner of the frame. Zoom the lens to eliminate any shadow not eliminated by the Diffuser (*You can test this above water*).

## Deflector Use

The Deflector should be installed when using a slave unit to trigger an external strobe. The Deflector will block and redirect the camera's flash to an EV-controller or other slave unit which controls the external strobe's output. Remove the Diffuser before attempting to install the Deflector.

## Ikelite Housing Conversion Circuitry

This housing has Ikelite designed and patented Conversion Circuitry - page 8, built into the housing back. The Conversion Circuitry provides real TTL flash exposure when used with Ikelite DS series Substrobes. Once a DS-series substrobe is attached to the camera housing, the conversion circuitry is automatically powered after the strobe is turned on. Once attached, turn the strobe on first before turning on the camera.

## Attaching an Ikelite Strobe Arm to the Housing Handle

To attach an Ikelite Arm to your Housing Handle, depress the spring-loaded Handle Push Button until it stops. Gently slide the pronged end of the Ikelite Arm into the hole in the top of the Handle as shown.

When the Ikelite Arm is properly seated, the Handle Push Button will return to its starting position.

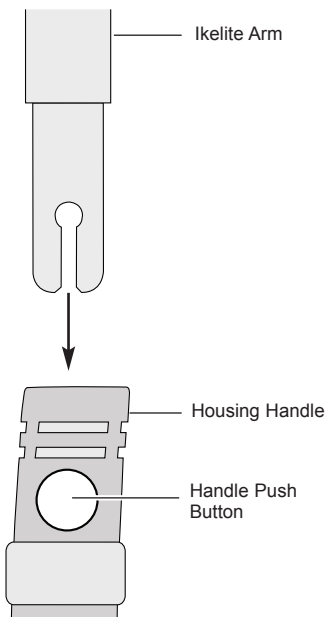

## Attaching a Sync Cord to the Housing

The Housing Bulkhead is designed to accept only an Ikelite 5-pin TTL Sync Cord.

1. Lightly lubricate the Sync Cord O-ring. Use ONLY Ikelite lubricant (supplied with housing).
  2. Remove Bulkhead Cap from Housing Bulkhead.
  3. Line up the Sync Cord Pins with the corresponding Bulkhead receptacles. Gently insert Sync Cord into Bulkhead. DO NOT force this installation. *If the Sync Cord does not seat properly inside the Bulkhead, then the pins and receptacles are improperly aligned (repeat Step 3).*
  4. Tighten the Knurled Nut snugly using your Index finger and thumb. DO NOT use pliers or other tools to tighten the Knurled Nut.
- Always remove the Sync Cord from your Housing when not in use and replace the Bulkhead Cap.

**Note:** The camera flash will not fire when an Ikelite DS series substrobe is turned on and properly connected to the housing.

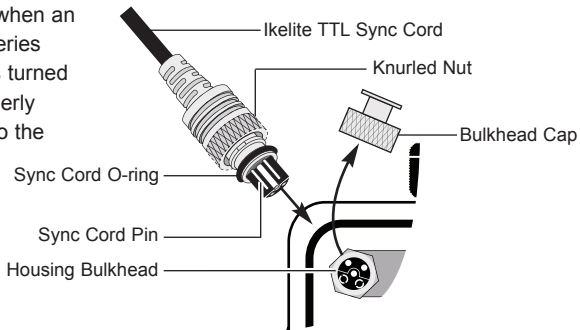

## Turn Camera On

Turn the camera on and operate each of the housing controls to get a feel for using the camera in the housing. Take a few test shots on land.

**You are now ready to shoot underwater photos and video!**

## Entering the Water

As soon as you enter the water, take a moment and check the housing to see that it is properly sealed.

Next, check to see if there are any bubbles on the face of the lens port. If there are, take your finger and remove them. If there are bubbles on the lens port they can produce soft focus spots in your photos or video.

## Maintenance

### Lens Port

Treat the glass or acrylic in the lens port as a camera lens. After use, rinse and gently dry the outside lens port to avoid water spotting. To clean, use a mild soap solution or lens cleaner. Do not rinse the inside port glass. **Do not use alcohol or window cleaner on the Lens Port.**

### Lubricant

- Ikelite provides silicone lubricant with the housing. We recommend you use **only** Ikelite lubricant on Ikelite products. Other brands may cause the main housing o-ring to swell and not seal properly.
- Use only enough lubricant to lightly cover the main housing o-ring or lubricate a sticky control. Wipe off any excess lubricant with a clean cloth. Lubricant is not a sealant; it is used to reduce friction. Excessive lubricant can collect sand and dirt which may interfere with proper sealing.

### CAUTION:

**Never use spray lubricants as the propellant ingredient can cause the plastic housing to crack or o-rings to swell.**

### O-ring Storage

When storing the housing, remove the main housing o-ring. Lightly lubricate the o-ring until it appears shiny and place in a small resealable plastic bag. Use only Ikelite lubricant. Place the bag inside the housing and store until needed.



## Housing Maintenance

Your Ikelite Digital Housing should be given the same care and attention as your other photographic equipment. In addition to normal maintenance, we recommend that the housing be returned to Ikelite periodically to be checked and pressure tested.

- **Do Not** leave the camera and housing in direct sunlight for prolonged periods. Heat may damage the camera.
- **Do Not** ship the camera in the housing.
- Before using the housing, always check the tightness of the **set screw** in each control knob. Check each **control gland** penetrating the housing to make sure they are tight. There is a slight chance that either could vibrate loose during travel.
- Keep the main housing o-ring clean and lightly lubricated. To lubricate, remove the o-ring from the back. Put a small amount of Ikelite lubricant on your fingers. Pull the o-ring through your fingers to apply a **thin** coating of lubricant. Only apply enough lubricant to make the o-ring feel slick. **Do Not stretch the o-ring**. This light coating of lubricant will help to keep the o-ring from drying out and will help to show a dark sealing line when the housing back is properly sealed.
- Keep the area where the o-ring fits and the sealing surface of the housing clean.
- Rinse the housing exterior thoroughly in freshwater after each saltwater use. Depress push buttons repeatedly in freshwater to eliminate trapped saltwater. Dry with a soft cloth. Dry lens port to eliminate water spotting. After several uses in saltwater, soak the housing exterior in a mild soap solution, rinse and dry before storing. When storing the housing, remove the back o-ring, lightly lubricate, and place in a plastic bag. Place the plastic bag with o-ring inside the housing for safe keeping.
- If removing a housing push button, **Do Not** re-use the E-clip. Contact Ikelite for replacement E-clips (part 0319.12).
- Leave lid snaps in the open position when not using the housing for extended periods.

## Control Maintenance

Ikelite controls are designed to provide years of reliable service with minimal maintenance.

- Push button controls normally require no maintenance other than rinsing in freshwater after saltwater use. Depress each push button in freshwater several times to eliminate trapped saltwater. If a push button control becomes difficult to push or if it sticks when depressed, soak the housing in luke warm freshwater. After a few minutes, operate the push button. If this does not correct the problem, return the housing to Ikelite for maintenance. If you are on a trip and unable to return the housing immediately, a push button may be lubricated by pressing and holding the push button all the way in. Then, use your finger or other small object to place a small amount of lube at the base of the shaft inside the housing. Press and release the push button several times until the lube is worked up into the o-ring.
- Some of the controls have long shafts. These controls can be pulled out, exposing the shaft see diagrams B and C - page 19. To lubricate the control, gently pull on the knob until the stainless steel shaft is exposed. Lightly lubricate the shaft, then move the shaft in and out several times. This will lubricate the x-ring in the Ikelite control gland. This should be done before using the housing after a prolonged storage period, or once a week when the housing is in constant use.
- Some of the controls have a short shaft and cannot be pulled out exposing the shaft for lubrication. In the unlikely event one of these controls sticks or becomes difficult to operate, you can remove the control from the housing and lubricate it, or return the housing to Ikelite for maintenance. To remove the control, diagram B - page 19, loosen the set screw in the knob (allen wrench required); remove the knob. If there is salt or dirt build-up on the exposed control shaft, clean the shaft. Open the housing and gently slide the control shaft out of the control gland. Clean and lightly lubricate the shaft, including the end of the shaft.

## Control Maintenance - continued

Slide the shaft back into the control gland and gently slide it back and forth a few times without fully removing the shaft from the gland.

Replace the knob noting the flat area on the shaft. The set screw in the knob should tighten down against the flat area on the control so the knob does not turn on the shaft.

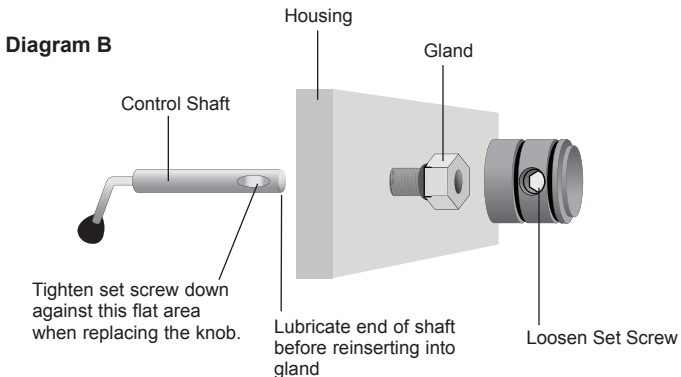

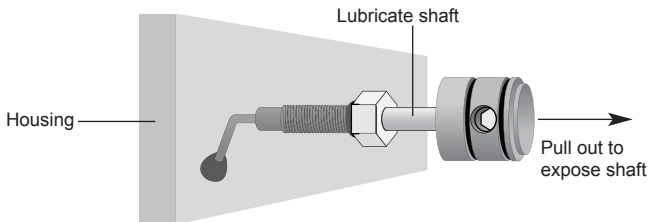

## Diagram C



## Photo Tips

- The number one rule in underwater photography is to eliminate as much water between the camera and subject as possible. Get as close as you can to the subject, then use the zoom. If you are using flash for still photos, subjects beyond 6 feet (1.8m) will not have much color regardless of strobe power.
- Photograph in clear water; do not stir up the sand or silty bottom. If backscatter becomes a problem in the environment you are photographing, an external flash will help eliminate much of the backscatter.
- Many digital cameras have a slight lag time between when you press the shutter release button and the camera actually takes the picture. Hold the housing steady a second or two after pressing the shutter release button.
- Do not shoot down on subjects as they will quite often blend into the background and be difficult to see in the photograph. Shoot subjects straight on or shoot up at a slight angle using the blue water as a contrasting background. Do not shoot into the sun.
- When using daylight or flash, if your camera consistently over or underexposes the image, you may want to adjust your camera's exposure compensation  settings.
- If you error in exposure, it is better to have the image slightly underexposed rather than overexposed. An overexposed image is missing color information which cannot be adjusted in a photo processing program. A slightly underexposed image has color information that can be adjusted.
- It is important to respect all living creatures underwater, including people, marine life, and coral. While we encourage people to get close to their subjects when taking a photograph, they should not touch, lie on, or in any way disturb the things they find underwater.

## Troubleshooting

Problem	Solution
Push buttons or controls are sticky and hard to operate	<ul style="list-style-type: none"><li>- Remove the camera and rinse the closed housing in freshwater. Vigorously press each push button in and out several times to release any trapped saltwater or debris.</li><li>- Press a sticky push button all the way in and place a small amount of lubricant on the small end of the push button shaft at its base. Release and operate the push button several times to distribute the lubricant.</li><li>- If a control is sticky, grab the control knob, pull it out, and then push back in. If still sticky, see the Control Maintenance section - pages 18 &amp; 19.</li><li>- Return housing to Ikelite for routine maintenance.</li></ul>
Image is over/underexposed, or a corner of the image is dark	<ul style="list-style-type: none"><li>- Check that the camera flash or strobe is firing when taking a picture. Camera flash should be forced "on."</li><li>- Make sure the deflector is installed when you are using a non-wired external strobe with a slave.</li><li>- Make sure the diffuser is installed when you are NOT using an external strobe.</li><li>- When using an external strobe, make sure it is turned on, set properly, and its battery is charged.</li><li>- Check any corded connection points.</li><li>- Change camera shutter speed or aperture.</li><li>- Move closer to or further away from the subject.</li><li>- Adjust Flash Exposure Compensation  </li><li>- For extreme overexposure turn on the ND neutral density filter.</li></ul>

<b>Problem</b>	<b>Solution</b>
Camera does not take a picture	<ul style="list-style-type: none"> <li>- Install a fully charged battery.</li> <li>- If using a “lever type” zoom control, make sure the control is centered and not engaged.</li> <li>- There is not enough available light for the camera to properly focus. Add a focusing light or strobe with a built-in focusing light to your system.</li> <li>- Select macro mode (if applicable) when shooting close-ups.</li> </ul>
Housing is hard to close	<ul style="list-style-type: none"> <li>- Make sure the camera is mounted properly on the camera tray and housing controls are out of the way.</li> <li>- Main housing o-ring is not seated properly.</li> </ul>
Fogging occurs on the Lens Port	<ul style="list-style-type: none"> <li>- Humid air is trapped inside the housing. The camera produces heat and may condense any trapped moisture forming fog on the lens port. Close the housing in an air-conditioned room or vehicle, or in front of an air-conditioner.</li> <li>- The housing should not be direct in sunlight for an extended period of time.</li> <li>- Purchase desiccant packs also known as moisture munchers from a local camera store. Place one or two packs in your housing before each day of diving.</li> <li>- If moisture or water droplets are present around the controls or sealing areas, return the housing to Ikelite for evaluation.</li> <li>- Clean the main housing o-ring and sealing surface of the housing.</li> </ul>

<b>Problem</b>	<b>Solution</b>
Water enters the housing	<ul style="list-style-type: none"> <li>- Remove, clean and properly lubricate the main o-ring.</li> <li>- Look for hair, dirt, or foreign debris crossing the o-ring seal.</li> <li>- Reassemble the housing without a camera installed and pressure test or take diving.</li> <li>- Return housing to Ikelite for evaluation.</li> </ul>
Pictures are too blue or too green	<ul style="list-style-type: none"> <li>- Use custom (manual) white balance if available. Reset for each working depth or when attaching a color correcting filter.</li> <li>- Add an optional color correcting filter.</li> <li>- Add an external strobe.</li> <li>- Move in closer to your subject when taking a picture.</li> </ul>

## Replacement Parts

**Main Housing O-ring 0110**

**Vinyl Port Cover 0200.08**

**Ikelite Lube 5020 (4 - 1cc tubes)**

For light lubrication of the main housing o-ring.

## Recommended Accessories

### Tray and Handle(s)

Add stability and gripping point(s) for comfortable use of the housing above and below water. Most tray and handle combinations offset the slightly positive buoyancy of the housings. Handles offer attachment points for external lighting systems.

### External Strobes

A separate external strobe adds color to restore the warmer colors filtered out by the water as well as to illuminate the subject. Add a second strobe to eliminate shadows and evenly light your subjects.

### Video Lighting

External video lights add color when using the video/movie mode of your camera. Primary video lights are specially color balanced to provide natural tones.



## Recommended Accessories - continued

### External Color Correcting UR/Pro Filters

#### (Blue Water or Green Water)

Color filters such as the UR-Pro Filter replace some of the reds, oranges and more natural tones that would otherwise be lost underwater. Effective in relatively shallow, sunny conditions, and available for tropical blue water and green water settings. For optimum results use in combination with “custom (manual) white balance.” Check your camera user guide for information on this option (if available).

For available light use only. Not recommended when using external strobes.

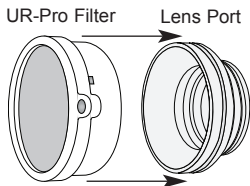

#### WD-4 Wide-Angle Conversion Dome 6430.4

The removeable WD-4 corrects light refraction underwater, restoring the camera's original angle of coverage. Approximately 3/4 of the camera's zoom range from the camera's widest angle setting can be used with the dome in place. Slight vignetting may occur at camera's widest angle setting.



#### External Macro Adaptor 9306.82

Allows attachment of 67mm threaded macro lenses from Inon and Epoque. NOT for use with 67mm threaded wide-angle lenses.



## Recommended Accessories - continued

### Please Read If Using an EV Manual Controller

The EV-Controller used with Ikelite DS Substrobes has two user settings. One setting is for strobe selection, the other is for pre-flash “P” or non pre-flash “⊘.” Most cameras use a pre-flash. This means the EV-Controller should be set to the pre-flash “P” position when used with this camera as a slave. If a manual mode is used that does not emit a pre-flash, set the EV-controller to the non pre-flash “⊘” position.

A full range of accessories is available to support your housing. Please visit [www.ikelite.com](http://www.ikelite.com) to see the most current information about recommended accessories for your housing.

### Customer Support

Please read the troubleshooting section of this instruction manual before contacting Ikelite Technical Support.

Ikelite Underwater Systems  
Service Department  
50 West 33rd St.  
Indianapolis, IN 46208 USA

Email: [ikelite@ikelite.com](mailto:ikelite@ikelite.com)  
Phone: 317-923-4523

### Limited Warranty

This Ikelite product is warranted against any manufacturing defects for a period of one (1) year from the original date of purchase. Defective products should be returned to Ikelite postage paid. Ikelite will, at its sole discretion, repair or replace such products, and will return to customer postage paid. All other claims of any nature are not covered. Except as mentioned above, no other warranty expressed or implied applies to this Ikelite product.

## Returning Products For Service

Ikelite is most interested in performing any service to ensure that all products perform as intended. Evidence of purchase date must be provided to obtain warranty service.

No prior authorization is required. You may return directly to us or through your dealer. Please include a brief description of the problem, any relevant email correspondence, and/or instructions on what you want us to do. Always include name, shipping address, email address, and phone number inside of the package. Send postage paid to:

*Ikelite Underwater Systems  
Attention: Service Department  
50 West 33 Street  
Indianapolis, IN 46208 USA*

No reimbursements for postage paid will be issued.

You may also want to insure the package.

### **Returning Products for Service (outside the United States)**

For the separate international customs documentation form that you complete to accompany the shipment, please state or designate that the enclosed products were originally manufactured in the USA and are being returned to the manufacturer for repair service. Value of the equipment listed for customs purposes should be zero.

## **Product Registration**

Please go to [www.ikelite.com](http://www.ikelite.com) to register your Ikelite housing within 15 days of purchase.



**Ikelite Underwater Systems  
50 West 33rd Street  
Indianapolis, IN 46208 USA**

**[www.ikelite.com](http://www.ikelite.com)**