

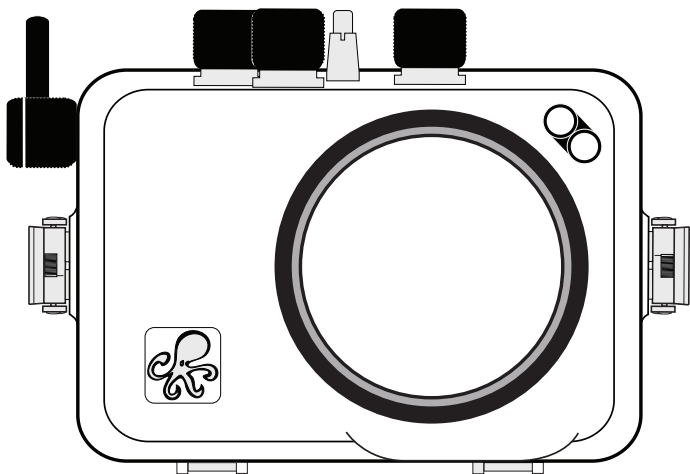

Digital Housing

Instruction Manual

6116.11 Sony RX100 II (DSC-RX100M2/B)



Thank you for your purchase of Ikelite equipment. Please read this instruction manual completely before attempting to operate or dive with this product. Please refer to the back page of this manual to register your Ikelite product.

Table of Contents

Specifications	P. 3
Package Contents	P. 3
Preparation	P. 4
Initial Camera Setup	P. 4
Parts of the Housing - Front View	P. 5
Parts of the Housing - Back View	P. 6
Opening the Housing	P. 7
Installing the Camera	P. 7
Using the Built-in Camera Flash	P. 8
Closing the Housing	P. 8
Usage	P. 9
Final Check	P. 9
Zoom Control	P. 9
Deflector Purpose	P. 9
Deflector Removal/Installation	P. 10
Diffuser Purpose	P. 10
Diffuser Installation/Removal	P. 10
Attach External Tray and Handle to Housing	P. 11
Attach Ikelite Strobe Arm to Housing	P. 11
Turn Camera On	P. 12
Entering the Water	P. 12
Maintenance	P. 12
Lens Port	P. 12
Lubricant	P. 12

Table of Contents - continued

Housing Maintenance.....	P. 13
Control Maintenance	P. 14
Photo Tips	P. 16
Troubleshooting	P. 17
Spare Parts	P. 20
Recommended Accessories	P. 20
Customer Support	P. 22
Limited Warranty	P. 23
Returning Products for Service	P. 23
Product Registration	P. 24

Specifications

Width	6.8 in (173 mm) including controls
Height	4.8 in (127 mm) including controls
Depth	5.4 in (140 mm) including controls and lens port
Weight	2.6 lb (1179 g) above water
Buoyancy	Slightly negative in freshwater

Package Contents

- Ikelite Digital Housing
- Silicone Lubricant
- Vinyl Port Cover
- Diffuser and Deflector
- Lanyard (attached to housing)
- Extra Control Tips

Preparation

This product has been water pressure tested at the factory and is depth rated to 200 ft. (60m). Thoroughly inspect and immerse the empty housing completely in water before installing a camera. If any fogging occurs or droplets of water enter the housing, do not install a camera. Clean the housing main o-ring and retest to make sure that it is watertight. Refer to the Troubleshooting section, page 17.

Please read your camera manual thoroughly to have a full understanding of each camera function.

If you are new to underwater photography, be sure to read the Photo Tips section, page 16.

Initial Camera Setup (before placing camera in housing)

- Set Mode Dial to “A” Aperture Priority. Manually adjust aperture setting to achieve the best exposure for your shooting conditions. The shutter speed will be locked at 1/30th second. If a faster shutter speed is desired, set Mode Dial to “M” Manual mode to manually adjust both aperture and shutter speed settings.
 - Set Image Size to “L: 17M” and Aspect Ratio to “16:9” widescreen view.
 - Set Quality to “Fine.”
 - Set Drive Mode to “Single Shooting.”
 - Set Flash Mode to  “Fill-flash” and Focus Mode to “Single-shot AF.”
 - Set Autofocus Area to “Center” and ISO to “200.”
 - Set Metering Mode to “Center” and White Balance to “Auto WB.” For best results, manually set white balance for each working depth.
 - Set DRO/Auto HDR, Digital Zoom, and AF Illuminator to “OFF.”
 - Set SteadyShot to “On” and Auto Review to “10 Sec.”
 - Set Red Eye Reduction to “Off” and Auto Review to “5 Sec.”
 - Insert and Format an SDHC memory card.
 - Set Date and Time.
- * All menu functions not mentioned should be set to user preference.

Parts of the Housing - Front View

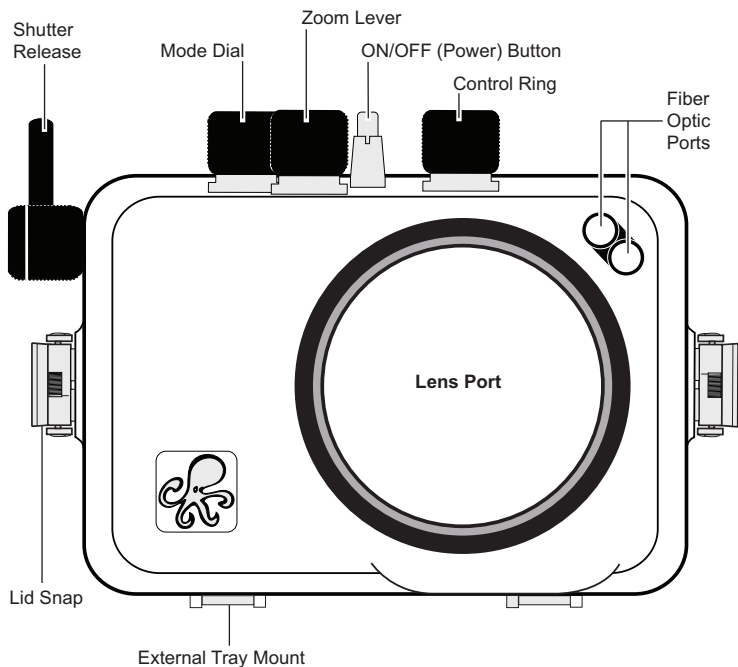

Control Ring: To properly engage the Control Ring on the surface or in shallow water, apply slight downward pressure as you rotate the knob.

Parts of the Housing - Back View

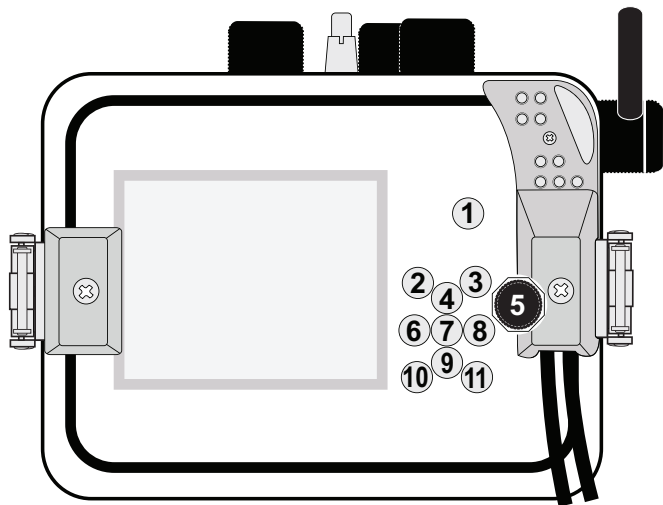

Housing Controls

1. MOVIE Button
2. Fn Function Button
3. MENU Button
4. DISP Display / UP Button
5. * Control Wheel
6. Drive Mode / Left Button
7. Set / Tracking Focus
8. Flash Mode / Right Button
9. Exp. Comp. / Down Button
10. Playback Button
11. Guide / Delete Button

* **Control Wheel Note:** A small section is “cut away” from the Control Wheel rotating rubber pad - page 7, diagram A. Rotate Control Wheel to its “cut away” resting position so it does not contact the camera when not in use.

Opening the Housing

Lid Snaps have a **Lock**.

To open housing, push Lid Snap Lock forward and lift as shown. Keep pressure on the Lid Snap so it does not fly open quickly. Some lid snaps have a lot of spring tension once they go over center, so keep a firm grip on the lid snap. Lid Snaps may be opened one at a time.

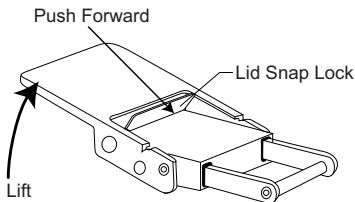

Installing the Camera

1. Remove any lanyard attached to the camera.
2. Pull out on each housing control until it stops. This will get the controls out of the way for installation of the camera.
3. Remove the back from the housing.
4. The mounting tray for the camera is secured to the housing back. Position the camera on the tray. **DO NOT** extend the camera flash.
5. Using a coin or screwdriver (preferred), secure the camera with the tray mounting bolt which threads into the camera's tripod socket - diagram A.

CAUTION:

Some camera tripod socket threads are plastic. The mounting bolt is metal. Do not cross thread or over tighten as you may damage the camera tripod socket threads.

* Control Dial "cut away." When not in use, rotate Control Dial so "cut away" is over camera dial and not contacting camera.

Diagram A

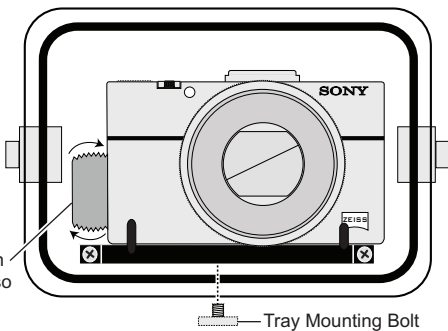

Using the Built-in Camera Flash

DO NOT extend the camera flash before placing camera in housing.

If you are shooting with the built-in camera flash, remove the factory installed Deflector and install the Diffuser (included), see page 10. The camera's built-in flash **CANNOT** be used with optional Wide-Angle or Accessory lenses.

For the best results, we recommend using an external Ikelite Strobe with the removable housing Deflector installed.

Closing the Housing

1. Place housing face down in your lap.
2. Check to see that there is an o-ring on the housing back that is clean and in its proper location.
3. Guide the back onto the housing. The o-ring should touch the housing all the way around. There should be an even gap all the way around between the housing and the housing back.
4. Lift the lid snaps so they are extended and place the lid snap into the corresponding hook on the housing back.
5. To close the housing, push down on the lid snaps until they snap into place. Lid snaps on opposite sides of the housing should be closed at the same time. Be sure they are down far enough to engage the lid-snap lock.

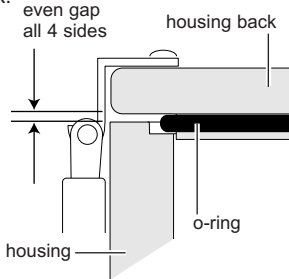

Usage

Final Check

The clear housing permits instant visual inspection of the camera and sealing surfaces as well as complete monitoring of controls and camera LCD screens. This housing has been factory water pressure tested to 200 ft (60 m).

Once the housing is closed, check the o-ring seal. Check the gap between the housing back and the housing. It should be even all the way around the housing.

Look through the clear plastic back at the o-ring. You should see a darkened area where the o-ring is compressed against the housing back. If you do not see an even black compression seal all the way around the back, open the lid snaps, reset the housing back and close the lid snaps. Visually check the seal again.

Zoom Control (lever type only)

After you have used the housing's zoom control, it must be returned to the center position to disengage. If the housing zoom control is pushing the zoom lever in either direction, you may not be able to take a picture or access other functions. This is because the camera is receiving a signal from the engaged zoom control.

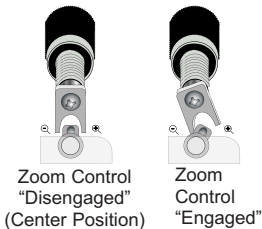

Deflector Purpose

The Deflector should be installed when using any external strobe. The Deflector will block and redirect the camera's flash to an optional AF35 slave unit or fiber optic cord, which sends the firing signal to the strobe. The Deflector also stops the built-in flash from creating backscatter in the image. Remove the Diffuser when using the Deflector.

Deflector Removal/Installation

The factory installed flash Deflector should be removed when using **ONLY** the built-in camera flash and no external strobes. Pull the Deflector away from the inside of the housing front to remove. To install, line up the corresponding Velcro dots on the housing front and press the Deflector back into its factory installed position next to the lens port. When properly installed, the Fiber Optic Holes should line up with the housing Fiber Optic Ports, page 5.

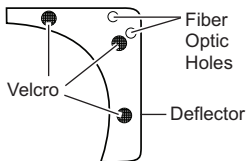

Diffuser Purpose

When shooting close-up photographs, the lens port on the housing can block a portion of the light from the built-in camera flash. This can result in a shadow in a lower corner of the picture frame. The Diffuser will help eliminate the shadow. In addition, you can zoom in if necessary.

Diffuser Installation/Removal

The included Diffuser should only be used when shooting with the built-in camera flash. Always remove the Deflector **before** using the built-in camera flash and Diffuser.

To install the diffuser, push the “Cut-out” Section into the port groove until it stops as shown. To remove, grab the top of the Diffuser and pull away from the port.

Note the Small Hole. To avoid losing the diffuser, you can attach a fishing line or string to this hole.

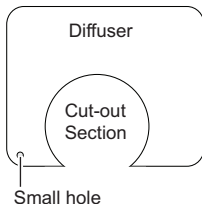

Diffuser properly installed in port groove

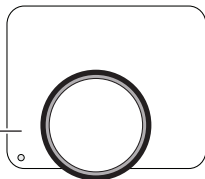

Attach External Tray and Handle to Housing

1. Place the housing upside down on a flat surface or in your lap so that the housing port is facing toward you as shown.
2. Line up the 3/8" tray holes with the housing mounts. If the tray is positioned properly, the handle will be on your left side facing down.
3. Place a shoulder washer in each 3/8" tray hole with the small end of the washer facing down.
4. With your free hand, insert and rotate the 12-24 x 1/2" screws clockwise until threaded into the housing mounts. Finish tightening the tray to the housing using a flathead screwdriver. Do not overtighten.

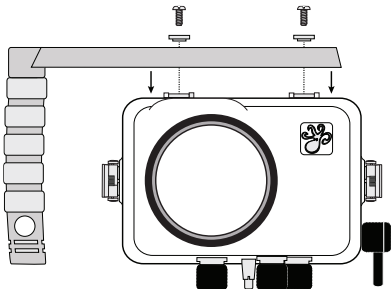

Attach Ikelite Strobe Arm to Housing Handle

If you have purchased an optional Ikelite Tray and Handle for your housing, an Ikelite Strobe Arm will easily attach to the Handle by depressing the spring-loaded Handle Push Button until it stops. Gently slide the pronged end of the Ikelite Arm into the hole in the top of the Handle as shown.

When the Ikelite Arm is properly seated, the Handle Push Button will return to its starting position.

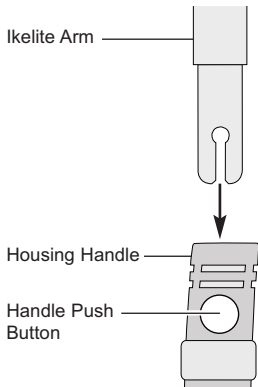

Turn Camera On

Turn the camera on and operate each of the housing controls to get a feel for using the camera in the housing. Take a few test shots on land.

Note: Since the housing is designed for underwater use, the controls may feel slightly different when under water pressure.

Entering the Water

As soon as you enter the water, take a moment and check the housing to see that it is properly sealed.

Next, check to see if there are any bubbles on the face of the lens port. If there are, take your finger and remove them. If there are bubbles on the lens port they can produce soft focus spots in your photos or video.

Maintenance

Lens Port

Treat the glass or acrylic in the lens port as a camera lens. After use, rinse and gently dry the outside lens port to avoid water spotting. To clean, use a mild soap solution or lens cleaner. Do not rinse the inside port glass. **Do not use alcohol or window cleaner on the Lens Port.**

Lubricant

- Ikelite provides silicone lubricant with the housing. We recommend you use **only** Ikelite lubricant on Ikelite products. Other brands may cause the main housing o-ring to swell and not seal properly.
- Use only enough lubricant to lightly cover the main housing o-ring or lubricate a sticky control. Wipe off any excess lubricant with a clean cloth. Lubricant is not a sealant; it is used to reduce friction. Excessive lubricant can collect sand and dirt which may interfere with proper sealing.

CAUTION:

Never use spray lubricants as the propellant ingredient can cause the plastic housing to crack or o-rings to swell.

Housing Maintenance

Your Ikelite Digital Housing should be given the same care and attention as your other photographic equipment. In addition to normal maintenance, we recommend that the housing be returned to Ikelite periodically to be checked and pressure tested.

- **Do Not** leave the camera and housing in direct sunlight for prolonged periods. Heat may damage the camera.
- **Do Not** ship the camera in the housing.
- Before using the housing, always check the tightness of the **set screw** in each control knob. Check each **control gland** penetrating the housing to make sure they are tight. There is a slight chance that either could vibrate loose during travel.
- Keep the main housing o-ring clean and lightly lubricated. To lubricate, remove the o-ring from the back. Put a small amount of Ikelite lubricant on your fingers. Pull the o-ring through your fingers to apply a **thin** coating of lubricant. Only apply enough lubricant to make the o-ring feel slick. **Do Not stretch the o-ring**. This light coating of lubricant will help to keep the o-ring from drying out and will help to show a dark sealing line when the housing back is properly sealed.
- Keep the area where the o-ring fits and the sealing surface of the housing clean.
- Rinse the housing exterior thoroughly in freshwater after each saltwater use. Depress push buttons repeatedly in freshwater to eliminate trapped saltwater. Dry with a soft cloth. Dry lens port to eliminate water spotting. After several uses in saltwater, soak the housing exterior in a mild soap solution, rinse and dry before storing. When storing the housing, remove the back o-ring, lightly lubricate, and place in a plastic bag. Place the plastic bag with o-ring inside the housing for safe keeping.
- If removing a housing push button, **Do Not** re-use the E-clip. Contact Ikelite for replacement E-clips (part 0319.12).
- Leave lid snaps in the open position when not using the housing for extended periods.

Control Maintenance

Ikelite controls are designed to provide years of reliable service with minimal maintenance.

- Push button controls normally require no maintenance other than rinsing in freshwater after saltwater use. Depress each push button in freshwater several times to eliminate trapped saltwater. If a push button control becomes difficult to push or if it sticks when depressed, soak the housing in luke warm freshwater. After a few minutes, operate the push button. If this does not correct the problem, return the housing to Ikelite for maintenance. If you are on a trip and unable to return the housing immediately, a push button may be lubricated by pressing and holding the push button all the way in. Then, use your finger or other small object to place a small amount of lube at the base of the shaft inside the housing. Press and release the push button several times until the lube is worked up into the o-ring.
- Some of the controls have long shafts. These controls can be pulled out, exposing the shaft; see diagrams B and C, page 15. To lubricate the control, gently pull on the knob until the stainless steel shaft is exposed. Lightly lubricate the shaft, then move the shaft in and out several times. This will lubricate the x-ring in the Ikelite control gland. This should be done before using the housing after a prolonged storage period, or once a week when the housing is in constant use.
- Some of the controls have a short shaft and cannot be pulled out exposing the shaft for lubrication. In the unlikely event one of these controls sticks or becomes difficult to operate, you can remove the control from the housing and lubricate it, or return the housing to Ikelite for maintenance. To remove the control, diagram B, page 15, loosen the set screw in the knob (allen wrench required); remove the knob. If there is salt or dirt build-up on the exposed control shaft, clean the shaft. Open the housing and gently slide the control shaft out of the control gland. Clean and lightly lubricate the shaft, including the end of the shaft.

Control Maintenance - continued

Slide the shaft back into the control gland and gently slide it back and forth a few times without fully removing the shaft from the gland. Replace the knob noting the flat area on the shaft. The set screw in the knob should tighten down against the flat area on the control so the knob does not turn on the shaft.

Diagram B

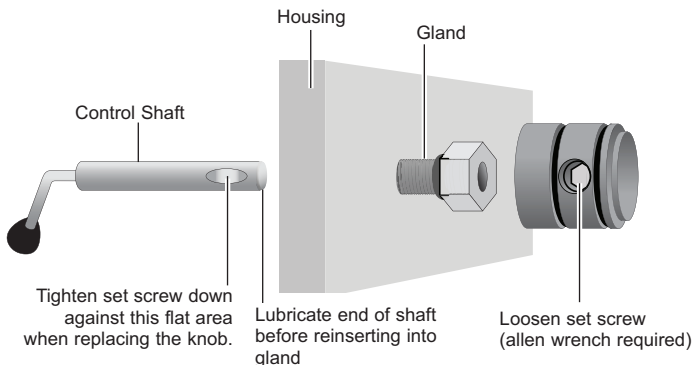

Diagram C

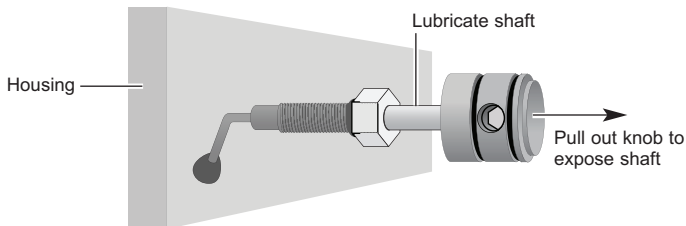







Photo Tips

- The number one rule in underwater photography is to eliminate as much water between the camera and subject as possible. Get as close as you can to the subject, then use the zoom. If you are using flash for still photos, subjects beyond 6 feet (1.8m) will not have much color regardless of strobe power.
- Photograph in clear water; do not stir up the sand or silty bottom. If backscatter becomes a problem in the environment you are photographing, an external flash will help eliminate much of the backscatter.
- Many digital cameras have a slight lag time between when you press the shutter release button and the camera actually takes the picture. Hold the housing steady a second or two after pressing the shutter release button.
- Do not shoot down on subjects as they will quite often blend into the background and be difficult to see in the photograph. Shoot subjects straight on or shoot up at a slight angle using the blue water as a contrasting background.
- When using daylight or flash, if your camera consistently over or underexposes the image, you may want to adjust your camera's exposure compensation  or flash exp. comp.  settings.
- If you error in exposure, it is better to have the image slightly underexposed rather than overexposed. An overexposed image is missing color information which cannot be adjusted in a photo processing program. A slightly underexposed image has color information that can be adjusted.
- It is important to respect all living creatures underwater, including people, marine life, and coral. While we encourage people to get close to their subjects when taking a photograph, they should not touch, lie on, or in any way disturb the things they find underwater.

Troubleshooting

Problem	Solution
Push buttons or controls are sticky and hard to operate	<ul style="list-style-type: none">- Remove the camera and rinse the closed housing in freshwater. Vigorously press each push button in and out several times to release any trapped saltwater or debris.- Press a sticky push button all the way in and place a small amount of lube on the small end of the push button shaft at it's base. Release and operate the push button several times to distribute the lube.- If a control is sticky, grab the control knob, pull it out, and then push back in. If still sticky, see the Control Maintenance section - pages 14 &15.- Return housing to Ikelite for routine maintenance.
Image is over/underexposed, or a corner of the image is dark	<ul style="list-style-type: none">- Check that the camera flash or strobe is firing when taking a picture. Camera flash should be forced "on."- Make sure the deflector is installed when you are using a non-wired external strobe with a slave.- Make sure the diffuser is installed when you are NOT using an external strobe.- When using an external strobe, make sure it is turned on, set properly, and it's battery is charged.- Check any corded connection points.- Change camera shutter speed or aperture.- Move closer to or further away from the subject.- Adjust Flash Exp. Comp.  .- Adjust Camera Exp. Comp. .

Problem	Solution
Camera does not take a picture	<ul style="list-style-type: none"> - Install a fully charged battery. - If using a “lever type” zoom control, make sure the control is centered and not engaged. - Another camera function is engaged, locking out the shutter control. - There is not enough available light for the camera to properly focus. Add a focusing light or strobe with a built-in focusing light to your system. - If applicable select macro mode for close-ups.
Housing is hard to close	<ul style="list-style-type: none"> - Make sure the camera is mounted properly on the camera tray and housing controls are out of the way. - Main housing o-ring is not seated properly.
Fogging occurs on the Lens Port	<ul style="list-style-type: none"> - Humid air is trapped inside the housing. The camera produces heat and may condense any trapped moisture forming fog on the lens port. Close the housing in an air-conditioned room or vehicle, or in front of an air-conditioner. - The housing should not be direct in sunlight for an extended period of time. - Purchase desiccant packs also known as moisture munchers from a local camera store. Place one or two packs in your housing before each day of diving. - If moisture or water droplets are present around the controls or sealing areas, return the housing to Ikelite for evaluation. - Clean the main housing o-ring and sealing surface of the housing.

Problem	Solution
Water enters the housing	<ul style="list-style-type: none"> - Remove, clean and properly lubricate the main o-ring. - Look for hair, dirt, or foreign debris crossing the o-ring seal. - Reassemble the housing without a camera installed and pressure test or take diving. - Return housing to Ikelite for evaluation.
Pictures are too blue or too green	<ul style="list-style-type: none"> - Use custom (manual) white balance if available. Reset for each working depth or when attaching a color correcting filter. - Add an optional color correcting filter OR add an external strobe. - Move in closer to your subject when taking a picture.

Spare Parts

Main Housing O-ring 0109

Control Ring “Rubber Sleeve” 0367.39

Vinyl Port Cover 0200

Ikelite Lube 5020 (4 - 1cc tubes)

For light lubrication of the main housing o-ring.

Recommended Accessories

Tray and Handle(s)

Add stability and gripping point(s) for comfortable use of the housing above and below water. Most tray and handle combinations offset the slightly positive buoyancy of the housings. Handles offer attachment points for external lighting systems.

External Strobes

A separate external strobe adds color to restore the warmer colors filtered out by the water as well as to illuminate the subject. Add a second strobe to eliminate shadows and evenly light your subjects.

Video Lighting

External video lights add color when using the video/movie mode of your camera. Primary video lights are specially color balanced to provide natural tones.

Recommended Accessories - continued

External Color Correcting UR/Pro Filters

(Blue Water or Green Water)

Color filters such as the UR-Pro Filter replace some of the reds, oranges and more natural tones that would otherwise be lost underwater. Effective in relatively shallow, sunny conditions, and available for tropical blue water and green water settings. For optimum results use in combination with “custom (manual) white balance.” Check your camera user guide for information on this option (if available).

For available light use only. Not recommended when using external strobes.

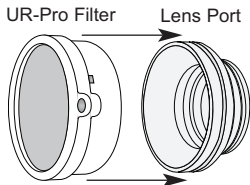

External Accessory Lenses

An external wide angle conversion lens increases angle of coverage so you can get much closer to your subject while still fitting everything in the frame. By reducing the amount of water between the subject and your camera lens, the resulting image will be more crisp and colorful. Attach 67mm threaded #6430 Ikelite W-30, Inon Type II and Epoque wide angle or macro lenses directly to the front of the housing port. Bayonet mount lenses are **not** compatible with this housing.

The housing port is threaded into the housing front.

Do not overtighten threaded accessory lenses into the housing port or accidental removal of the housing port could occur when removing the accessory lens.

No vignetting will be present underwater with the Ikelite W-30 lens attached.

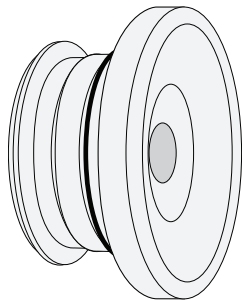

#6430 Ikelite W-30 Lens

Recommended Accessories - continued

A full range of accessories is available to support your housing. Please visit **www.ikelite.com** to see the most current information about recommended accessories for your housing.

Customer Support

Please read the troubleshooting section of this instruction manual before contacting Ikelite Customer Support.

Ikelite Underwater Systems
Service Department
50 West 33rd St.
Indianapolis, IN 46208 USA

Email: ikelite@ikelite.com
Phone: 317-923-4523

Limited Warranty

This Ikelite product is warranted against any manufacturing defects for a period of one (1) year from the original date of purchase. Defective products should be returned to Ikelite postage paid. Ikelite will, at its sole discretion, repair or replace such products, and will return to customer postage paid. All other claims of any nature are not covered. Except as mentioned above, no other warranty expressed or implied applies to this Ikelite product.

Returning Products For Service

Ikelite is most interested in performing any service to ensure that all products perform as intended. Evidence of purchase date must be provided to obtain warranty service.

No prior authorization is required. You may return directly to us or through your dealer. Please include a brief description of the problem, any relevant email correspondence, and/or instructions on what you want us to do. Always include name, shipping address, email address, and phone number inside of the package. Send postage paid to:

Ikelite Underwater Systems
Attention: Service Department
50 West 33 Street
Indianapolis, IN 46208 USA

No reimbursements for postage paid will be issued.

You may also want to insure the package.

Returning Products for Service (outside the United States)

For the separate international customs documentation form that you complete to accompany the shipment, please state or designate that the enclosed products were originally manufactured in the USA and are being returned to the manufacturer for repair service. Value of the equipment listed for customs purposes should be zero.

Product Registration

Please go to www.ikelite.com to register your Ikelite housing within 15 days of purchase.



**Ikelite Underwater Systems
50 West 33rd Street
Indianapolis, IN 46208 USA**

www.ikelite.com

© 2014 Ikelite Underwater Systems