



Manual Focus Port Extension 5510.75

Nikon AF-S VR Micro-NIKKOR 105mm f/2.8G IF-ED
Canon EF 100mm f/2.8 Macro USM
Canon EF 100mm f/2.8L Macro IS USM

Included



Ikelite Lube

Canon Spacer

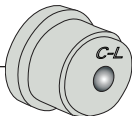

Allen Wrench

Washer

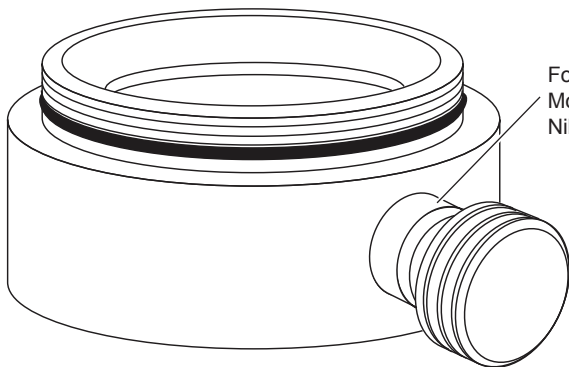

Focus Extension
Module with
Nikon "N" Spacer

General Information

Thank you for purchasing an Ikelite Manual Focus Port Extension. This Port Extension is **ONLY** compatible with the following lenses:

- Nikon AF-S VR Micro-NIKKOR 105mm f/2.8G IF-ED
- Canon EF 100mm f/2.8 Macro USM
- Canon EF 100mm f/2.8L Macro IS USM

The Port Extension comes assembled and ready for installation between a port body module and flat port module for use with the Nikon AF-S VR Micro-NIKKOR 105mm f/2.8G IF-ED lens. If using a Canon lens, you must change the Port Extension Control Spacer (page 3).

When using the #5510.75 Port Extension, both Canon lenses must be used with the #5510.16 port body only, otherwise the Focus Extension Control will not line up properly in relation to the lens focus ring. The Nikon VR lens will align properly when used with either port body #5510.16 or #5510.22.

Focus Extension Module's Control Knob (Nikon)

Due to the larger diameter of the Nikon VR lens, the Control Spacer is longer to obtain the proper control length. The Focus Extension Module comes assembled with the Nikon Control Spacer installed.

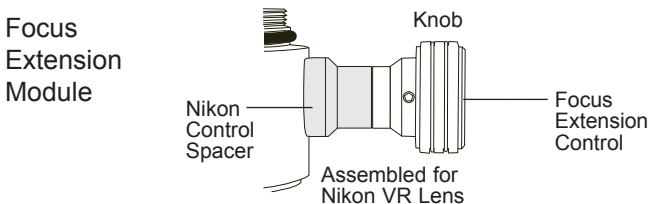

Focus Extension Module's Control Knob (Canon)

Changing the Port Extension Control Spacer

The Canon lens is smaller in diameter requiring the shorter Control Spacer be installed between the port body and knob.

To install the optional Canon Control Spacer, use the supplied allen wrench to loosen the knob allen screw. Remove the knob and Nikon Control Spacer. Install the Canon Control Spacer, remount the knob, and tighten the allen screw. Note there is a flat on the control shaft against which the allen screw should tighten.

NOTE: There are two Canon Macro lenses that can be used with this port extension. When using the Canon EF 100mm f/2.8 Macro USM (NOT the newer "L" IS version), install the supplied washer between the knob and "C-L" control spacer.

Focus Extension Module

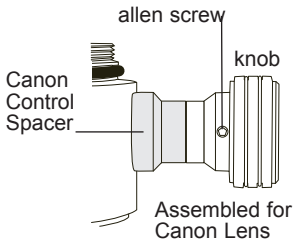

Control spacers are marked on the end with N for Nikon and C-L for Canon

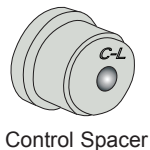

When using the Focus knob above water, inward pressure will have to be applied to the knob to rotate the focus barrel on the lens.

Preparing the Focus Extension Module for Installation

The extension o-ring comes from the factory clean and lightly lubricated. It should not be necessary to remove the o-ring, however we recommend applying a light coating of lubricant, just enough to make it feel slick. Remove any excess lubricant as it can collect foreign particles which can interfere with sealing.

If it becomes necessary to remove the o-ring from its groove, use a non-sharp instrument such as a small flat bladed screwdriver. O-rings can be cleaned with fresh water. To lubricate the o-ring, put a small amount of lubricant on your finger tips and draw the o-ring through your fingers. Use only a small amount of lubricant. When drawing the o-ring through your fingers do not stretch the o-ring.

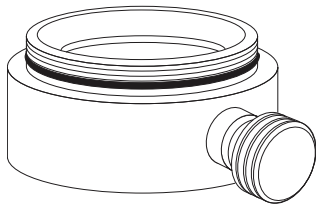

5510.75 Focus Extension Module

On the inside of the Extension Ring just below the internal threads is a flat sealing surface. This sealing surface is where the o-ring on the Port Body will seal when they are screwed together. Make sure it is clean.

Make sure all threads and sealing surfaces are clean before installation. Use a Q-tip and fresh water to clean if necessary.

Focus Extension Module is not to be used with Super-Wide Port Body #5510.10 or #5510.11.

Assembling the Flat Port with Port Extension

Assemble the Modular Flat Port by screwing each module together as shown. Modules only need to be hand tight.

#5510.35 Flat Assembly Module

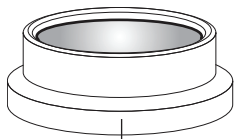

5510.75 Focus
Extension Module

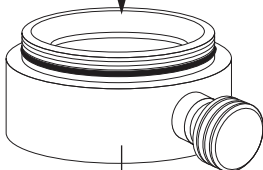

Port Body
Module (vary in
length)

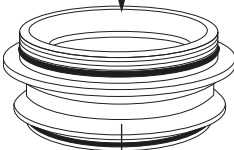

Port Lock

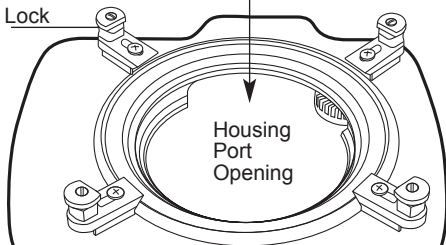

Housing
Port
Opening

Maintenance

After each dive, the exterior of the housing and port should be rinsed thoroughly in fresh water and dried with a soft cloth. Remove any water spots from the flat port assembly faceplate as they can cause blurry spots in the photographs.

After prolonged saltwater use, the exterior of the port and housing should be soaked in a mild liquid soap and water solution. Rinse thoroughly and dry with a soft cloth.

For prolonged storage, the port should be removed from the housing and the port sections should be unscrewed. All o-rings on port sections should be removed, cleaned, lightly lubricated, and reinstalled on each port section. If you screw the port sections back together for storage, only engage a few threads, leave the sealing o-ring visible.

CAUTION: When the port will not be used for prolonged periods we recommend unscrewing all sections of the port. If sections are not unscrewed for prolonged periods it can make unscrewing difficult.

Never use spray lubricants as the propellant ingredient can cause cracking in this product. Use ONLY Ikelite Lubricant.

Ikelite Limited Warranty

This Ikelite product is warranted against any manufacturing defects for a period of one (1) year from the original date of purchase. Defective products should be returned prepaid to Ikelite. Ikelite will, at its discretion, repair or replace such products, and will return to customer prepaid. All other claims, of any nature are not covered. Except as mentioned above, no other warranty expressed or implied, applies to this Ikelite product.

This port is warranted by Ikelite to a depth of 200' (60m).

Ikelite Technical Support

Email: ikelite@ikelite.com

Phone 317.923.4523

Fax 317.924.7988

Returning Products for Service

Ikelite is most interested in performing any service to ensure that all products perform as intended. Evidence of purchase date must be provided to obtain warranty service.

No prior authorization is required. You may return directly to us or through your dealer. Please include a brief description of the problem, any relevant email correspondence, and/or instructions on what you want us to do. Always include name, shipping address, email address, and phone number inside of the package. Send postage paid to:

*Ikelite Underwater Systems
Attention: Service Department
50 West 33 Street
Indianapolis, IN 46208 USA*

No reimbursements for postage paid will be issued.
You may also want to insure the package.

Returning Products for Service (outside the United States)

For the separate international customs documentation form that you complete to accompany the shipment, please state or designate that the enclosed products were originally manufactured in the USA and are being returned to the manufacturer for repair service. Value of the equipment listed for customs purposes should be zero.



**Ikelite Underwater Systems
50 West 33rd Street
Indianapolis, IN 46208 USA**

www.ikelite.com

Manual_Focus_Port_Extension_5510.75-03-1012