

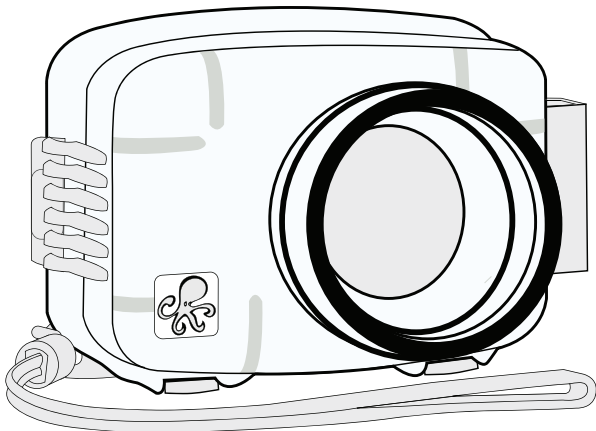

Digital Housing

Supplemental Instructions

6242.11 Canon S110 ULTRACompact



Size and Weight

Width6.1 in. (155mm) including controls

Height4.5 in. (114mm) including controls

Depth4.4 in. (112mm) including controls & lens port

Weight1.4 lb (635g)

BuoyancyNeutrally buoyant underwater

Initial Camera Setup

- Set camera mode switch to “Av” Aperture Priority.
- Set DR Correction to “Off” and ISO to “80.”
- Set White Balance to auto “AWB” and Frame to “Single Shot.”
- Set Light Metering to “Center Weighted Avg.”
- Set ND Filter to “ND Off”, and Still Image Aspect Ratio to “4:3.”
- Set Image Type to “JPEG” and Image Size to “L.”
- Set AF Frame to “1-point” and AF Frame Size to “Normal.”
- Set Digital Zoom to “Off” and AF-Point Zoom to “Off.”
- Set Servo AF to “On” and Continuous AF to “On.”
- Set Touch Shutter to “Off” and AF-assist Beam to “Off.”
- Set Review to “5 Seconds.”
- In the Flash Settings menu, set the Flash Mode to “Auto.”
Set Shutter Sync to “1st-curtain.”
Set Red-Eye Correction and Red-Eye Lamp to “Off.”
Set Safety FE to “On.”
- Set Spot AE Point to “AF Point” and Safety Shift to “On.”
- Set Review to “4 seconds” and Review Info to “Off.”
- Set Blink Detection to “On” and IS Mode to “Continuous.”
- Set Control Ring Func. to “STD” Default Control Av.
- Set Flash to forced ON (flash always fires) “.

Setup Notes:

If shadows are present, use two external strobes. Also, you can set Shadow Correct to “Auto”, which will help to lighten shadowed areas.

Set Macro Mode to “On” when shooting very close subjects.

The camera does NOT operate with TTL “automated” flash when in the “M” manual mode. “M” manual mode should NOT be used with the AF35 strobe.

Setup Notes (continued)

Camera functions can be assigned to the Control Ring by pressing the Ring Function button. Depress the Ring Function button until the desired function is highlighted in the camera LCD screen. Once the function is highlighted, it can be adjusted using the Control Ring. Refer to your camera owner's manual for additional information.

To use the camera in Manual mode, rotate the Mode Dial to "Tv" and set the shutter speed. Then, rotate the Mode Dial to "M" Manual Mode. Press the Ring Function repeatedly until it is set to "STD." Then, use the Control Ring to adjust Aperture setting as needed.

Attaching the Control Ring Gear (see illustration below)

The supplied Control Ring Gear is attached to the camera control ring by 3 small nylon allen Set Screws. Place the Control Ring Gear over the camera's control ring before installing the camera in the housing. The gear is a "press fit" over the lens and goes on one way with the allen screws closer to the camera body than the end of the lens. Gently tighten all three allen screws with the supplied Allen Wrench as show in the Diagram. **Do not** overtighten or you will damage the gear. Make sure to test it's function once installed.

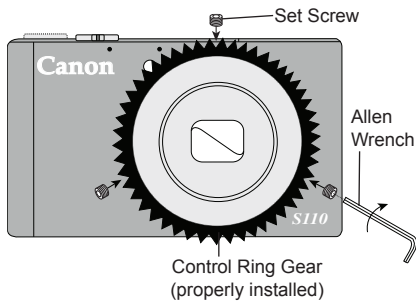

When installing the camera in the housing, make sure that the Control Ring Gear meshes properly with the small black housing gear.

Attaching the Control Ring Gear (continued)

When removing the Gear, leave the Set Screws in the Gear. The Set Screws are very small and easy to lose. Extra Set Screws are included with your housing. We recommend that you leave the gear installed as it makes rotating the camera control ring easier when out of the housing.

Parts of the Housing - Front View

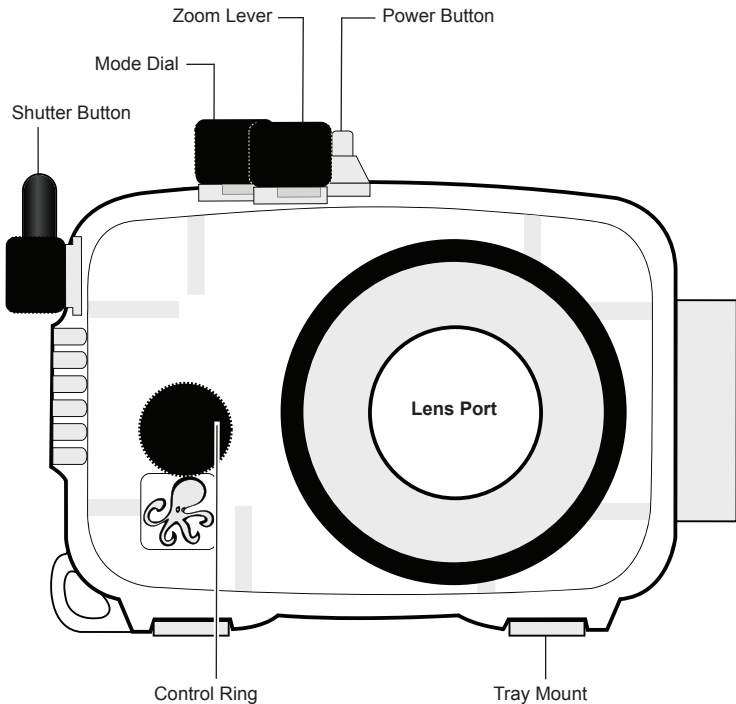

Parts of the Housing - Back View

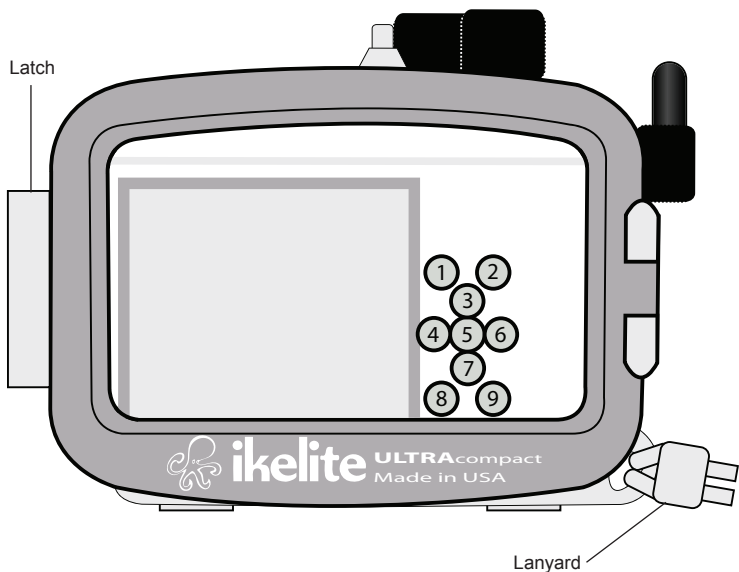



1. Ring Function Selector

2. Movie Button

3. Exposure Comp. , 

4. Macro , MF, 

5. FUNC./SET Button 

6. Flash Button , 

7. Display 

8. Playback Button 

9. MENU Button

External Accessory Lenses

Ikelite W-20 (6420) and W-30 (6430) Wide-Angle Conversion Lenses

The front of the lens port accepts the 6420 W-20, 6430 W-30, and other 67mm threaded wide angle and macro lenses or diopters without the need for an adapter. An external wide angle conversion lens increases angle of coverage so you can get closer to the subject while still fitting everything in the frame.

Vignetting will occur at widest angle camera lens setting with these lenses. Zoom in slightly to eliminate, or crop the image in post processing.

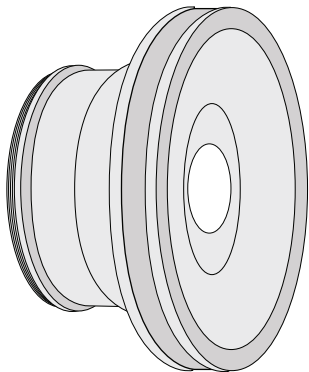

**Ikelite W-30 Wide Angle
Conversion Lens**

NOTE: Bayonet mount lenses cannot be used with this housing.

AF35 Strobe Package 4035

Ikelite strobes are much more powerful, recycle more quickly, and eliminate more backscatter than the camera's built-in flash. The AutoFlash AF35 (pictured at right) is an easy and affordable way to add a strobe to your system.

The AF35 is effective up to approximately 5 feet (1.5m) from the subject and restores the colors that are otherwise lost.

The AF35 is a great compliment, and an effortless, affordable way to add a flash to your new Ikelite point and shoot camera system.

Everything you need to get started is in the box. Just attach it to the bottom of your housing and start taking pictures!

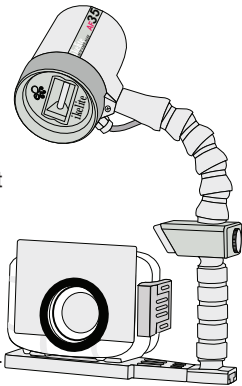

AF35 AutoFlash kit includes:

- AF35 strobe
- Flex arm
- AutoFlash sensor
- Handle with rubber grip
- Tray (single or dual)
- Mounting hardware

A full range of accessories is available to support your housing. Please visit www.ikelite.com to see the most current information about recommended accessories for your housing.



**Ikelite Underwater Systems
50 West 33rd Street
Indianapolis, IN 46208 USA**

www.ikelite.com